

Move into the future with reliable measurements



INSTRUMENTS
**TECHNO
TEST**

MRS-100 Series

Digital Telemeter



Making Measurement "Wireless"

MRS-100 Series



The MRS-100 Series is a lineup of small wireless units that enable to achieve stable communication with digital modulation, and this series can be used to easily make a strain-gage sensor or voltage-output sensor wireless. The MRS-100 Series can therefore be used to respond to rapid events in the automobile-related and other experiment and research fields, and the testing data can be sent almost in real-time. In addition, because the unit can be incorporated into a production line to make the load, pressure, and other sensors used for quality control wireless, it is useful for improving productivity.

Point 01 Even moving objects can be measured

When conducting tests involving moving objects or locations that cannot be wired, the MRS-100 Series eliminates the need for a cable—which can inhibit the movement of an object to be measured—so the unit can be utilized in various fields.

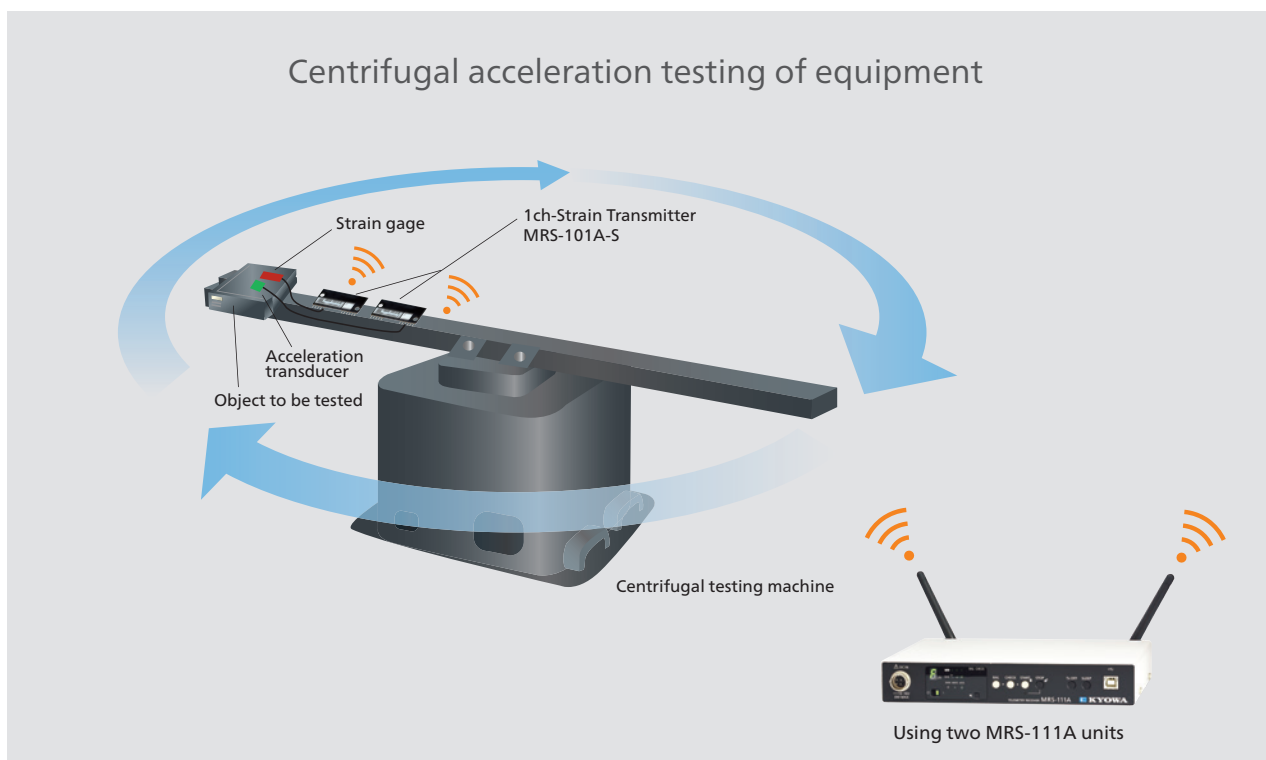

Point 02 Multi-channel measurement

When using a combination of 4-channel transmitters and receivers, each set has 4 channels, and up to 16 sets can be used to measure with up to 64 channels. However, in the case of a combination of 1-channel transmitters and receivers, the maximum is 16 sets with a total of 16 channels.



Point 03 Installation in narrow space

Because the transmitter is small compared to the conventional model, the unit can be easily installed even in limited space.

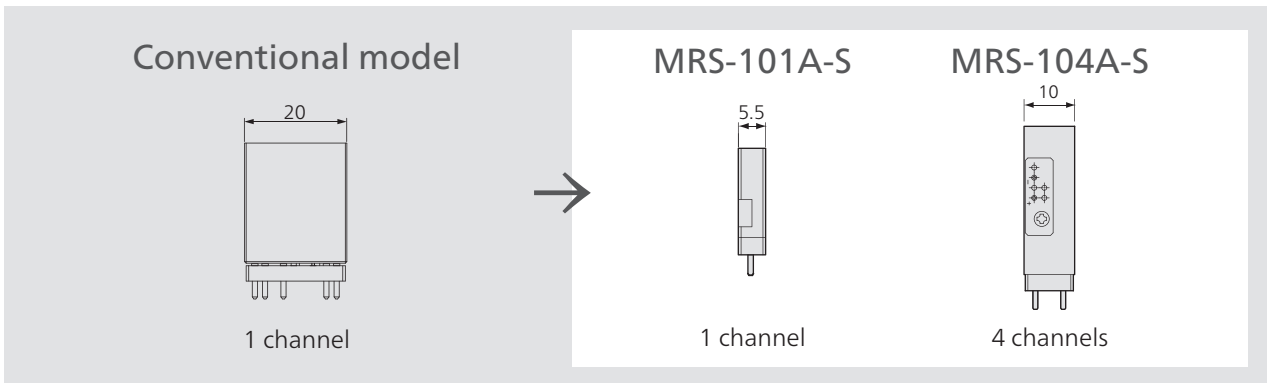

Point 04 Battery-powered measurement

The transmitter is battery-powered and can be used continuously for up to 34 hours. This increases the range of possible measurement targets.

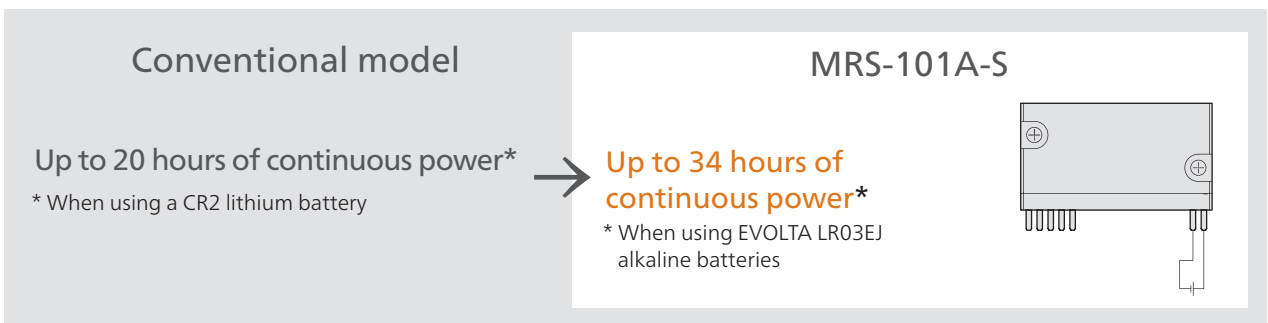

Point 05 Usable even outside of Japan

The MRS-100 Series has radio law certification in Japan, the USA, India, Thailand, and EU.



Configuration Diagram

Strain Measurement

Wirelessly measured data is sent from the strain transmitter to the receiver. Both the strain and stress on the measuring object are measured. We offer a lineup of 1-channel and 4-channel models, both of which support strain gages and strain-gage transducers.

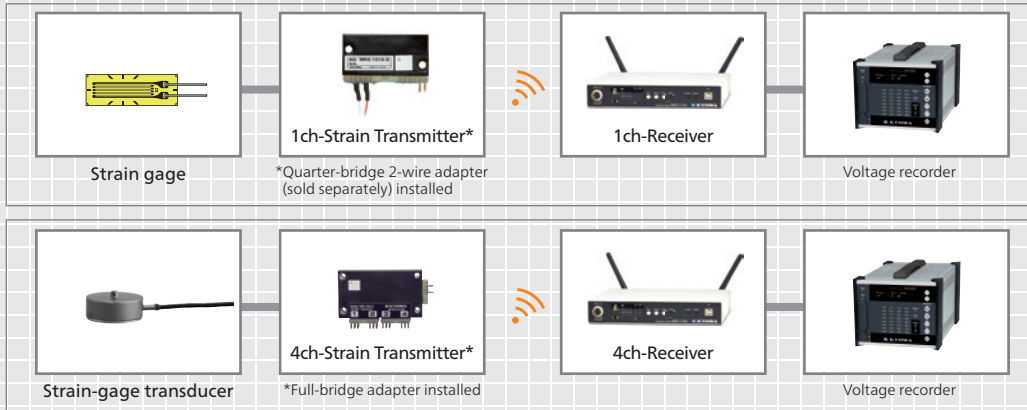

Voltage Measurement

Wirelessly measured data is sent from the 1-channel voltage transmitter to the 1-channel receiver. The voltage of the voltage-output sensor attached to the measuring object is measured.

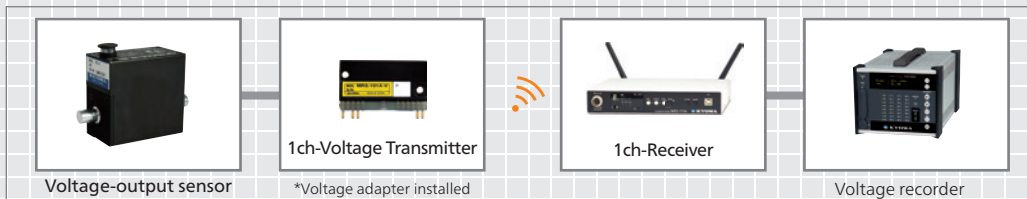

System Map

Transmitter

Strain measurement

1ch-Strain Transmitter
MRS-101A-S

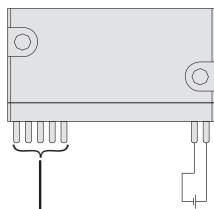

Strain-gage transducer

The MRS-104A-S is recommended for multi-channel strain measurement.

Voltage measurement

1ch-Voltage Transmitter
MRS-101A-V

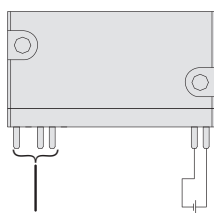

Voltage-output sensor
(Requires a separate power supply)

Receiver

The same receiver is used for both strain and voltage measurements.

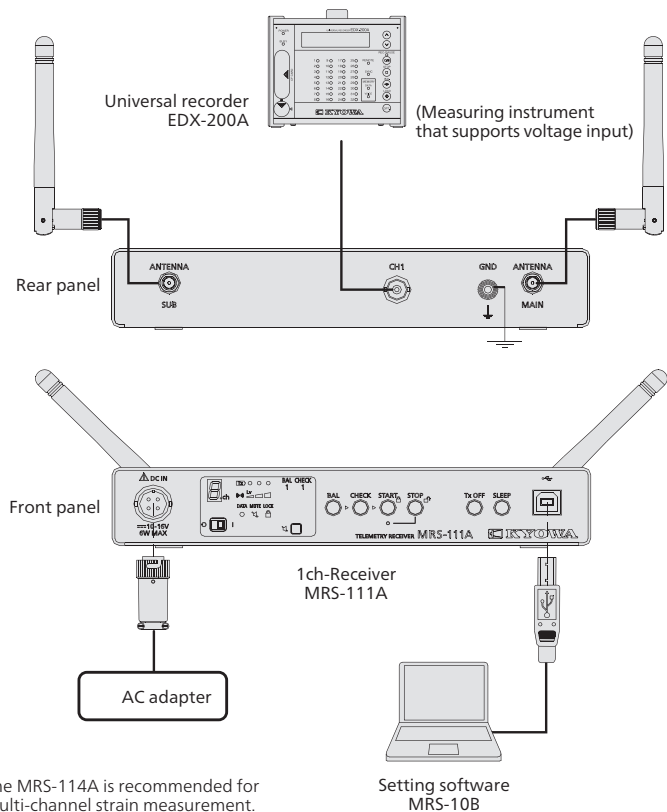

The MRS-114A is recommended for multi-channel strain measurement.

Setting software
MRS-10B

Applications

Wireless measurement can be utilized for various fields, including experiments and research as well as industrial measurement.

Press load monitoring

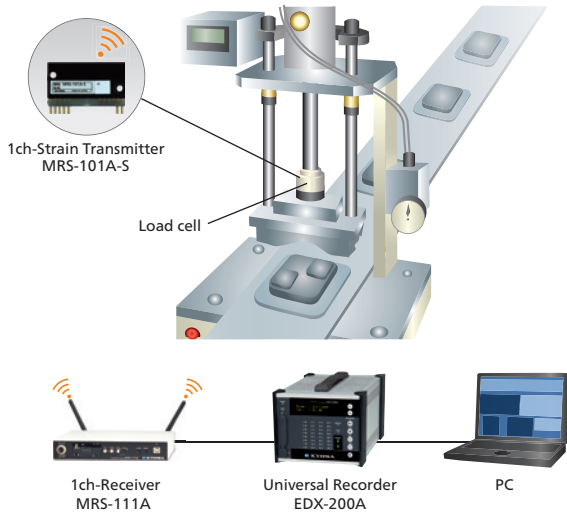

Drivetrain performance testing

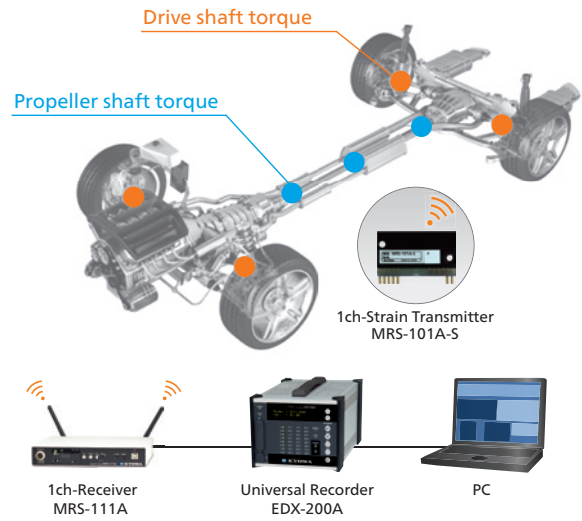

Small-motor performance testing

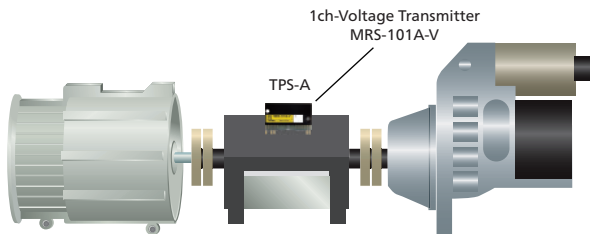

Evaluation of steering stability during actual vehicle driving

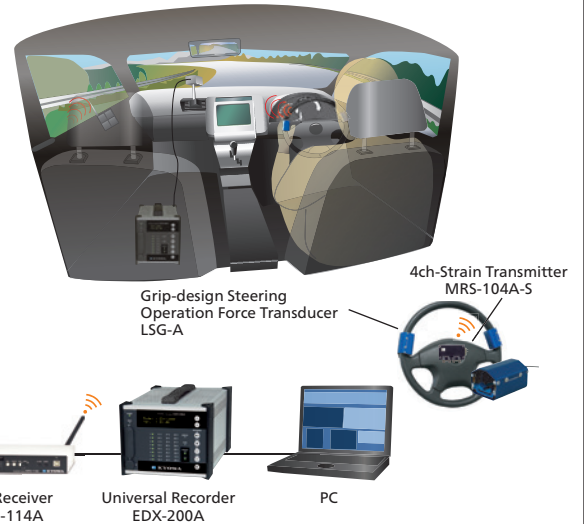

Measurement Room



Stress measurement of the moving parts of robots

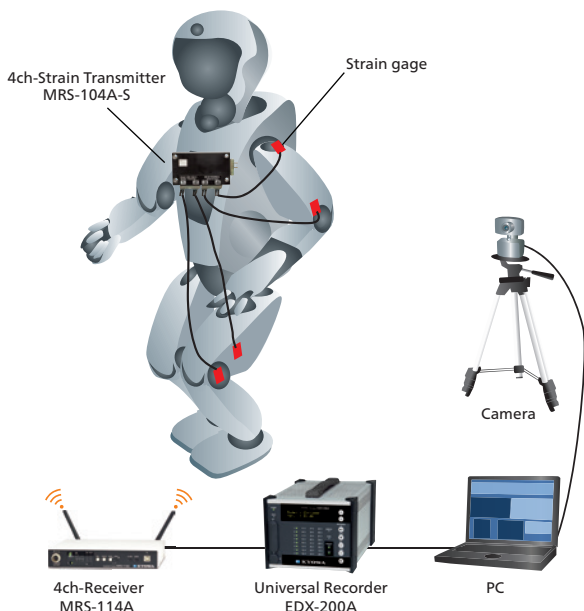

Golf club impact testing

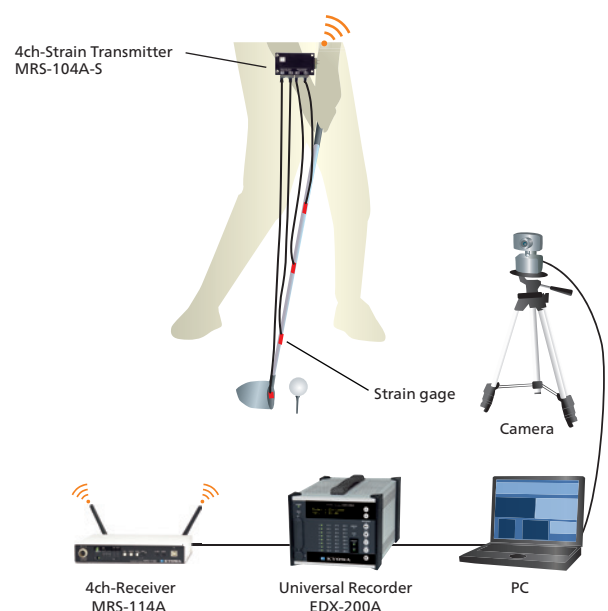

The number of receivers should be same as the number of transmitters to be used.

Specifications

Transmitter lineup

4ch-Strain Transmitter MRS-104A-S

- Multi-channel strain measurement

1ch-Strain Transmitter MRS-101A-S

- Moving object strain measurement

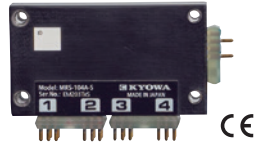

Measuring Targets	Strain gages (Quarter-bridge 2-wire system, 3-wire system, and full-bridge system), strain-gage transducers (For quarter bridge 2-wire system or 3-wire system, the adapter 1G2W or 1G3W is required respectively)	Strain gages (Quarter-bridge 2-wire system, and full-bridge system), strain-gage transducer (For quarter bridge 2-wire system, the adapter 1G2W is required)
Channels	4	1
Input Resistance	-	
Compatible Bridge Resistance	120 to 1000 Ω	
Gage Factor	2.00 fixed	
Bridge Excitation	1 VDC	
Absolute Input Voltage	-	
Measuring Range	1000, 2500, 5000, 10000, 25000 $\times 10^{-6}$ strain	
Range Accuracy	Within $\pm 0.15\%$ FS	
Balance Adjustment Range	Within $\pm 10000 \times 10^{-6}$ strain	
AD Resolution	16 bits	
Sampling Frequencies	1 channel: 4.8 kHz, 2 channels: 3.2 kHz, 3 channels: 2.4 kHz, 4 channels: 1.92 kHz	4.8 kHz
Stability	Zero point: Within $\pm 0.05 \times 10^{-6}$ strain per $^{\circ}\text{C}$ Sensitivity: Within $\pm 0.01\%$ / $^{\circ}\text{C}$	
Operating Temperature	-25 to 75 $^{\circ}\text{C}$	
Operating Humidity	20 to 85% (Non-condensing)	
Vibration Resistance	294.2 m/s ² (30 G), 10 to 500 Hz	
Shock Resistance	980.7 m/s ² (100 G), 11 ms	
Centrifugal Acceleration Resistance ^{*1}	980.7 m/s ² (100G). For the direction of centrifugal acceleration see Dimensions below.	29420 m/s ² (3000 G)
Power Supply	2.2 to 4.4 VDC	
Current Consumption	Within 62 mA (Test conditions: Power supply 3.0 V, bridge resistance 120 Ω)	Within 32 mA (Test conditions: Power supply 3.0 V, bridge resistance 120 Ω)
Hours of Continuous Use	Approx. 12 h [Lithium (CR2 manufactured by Panasonic)] Approx. 10 h [Ni-MH eneloop [®] (BK-4MCC, AAA cell $\times 2$)] Approx. 13 h [Alkaline EVOLTA (LR03EJ, AAA cell $\times 2$)] *Under the test conditions: 23 $^{\circ}\text{C}$, bridge resistance 120 Ω	Approx. 28 h [Lithium (CR2 manufactured by Panasonic)] Approx. 24 h [Ni-MH eneloop [®] (BK-4MCC, AAA cell $\times 2$)] Approx. 34 h [Alkaline EVOLTA (LR03EJ, AAA cell $\times 2$)] *Under the test conditions: 23 $^{\circ}\text{C}$, bridge resistance 120 Ω
Weight	Approx. 32 g	Approx. 10 g
Compliance	Directive 2014/53/EU (RED) Directive 2011/65/EU, (EU)2015/863 (10 restricted substances) (RoHS)	Directive 2014/53/EU (RED) Directive 2011/65/EU (6 restricted substances) (RoHS)

*1 When installing the transmitter on a rotating body, install a safety cover to secure safety from blown parts.

4ch-Strain Transmitter MRS-104A-S

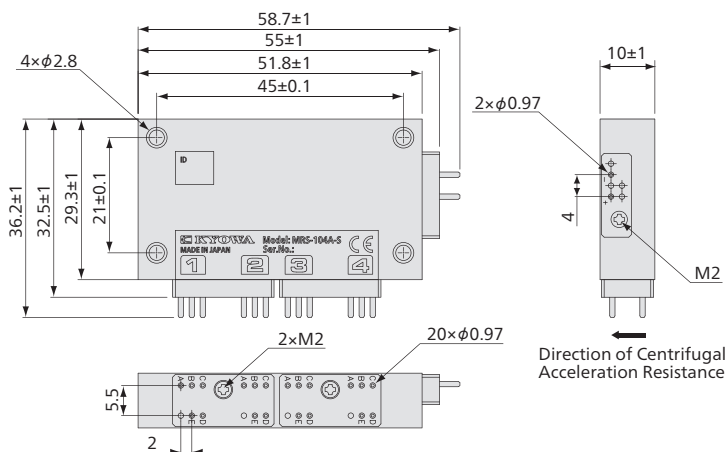

1ch-Strain Transmitter MRS-101A-S

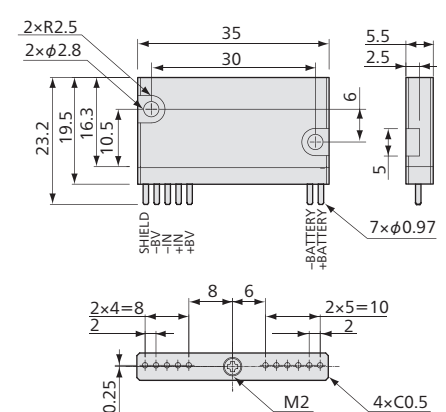

Standard Accessories

MRS-104A-S: Full-bridge adapter ADP-401 $\times 2$, JCIS10-70 miniature screw (M2 $\times 4$) $\times 3$, power adapter ADP-40P.
The above are installed in the transmitter. Fastening bracket $\times 2$, battery holder (AAA cell $\times 2$) for checking operation, ID label

MRS-101A-S: Adapter board ADP-01, JCIS10-70 miniature screw (M2 $\times 4$) $\times 1$.

The above are installed in the transmitter. Battery holder (AAA cell $\times 2$) for checking operation, ID label

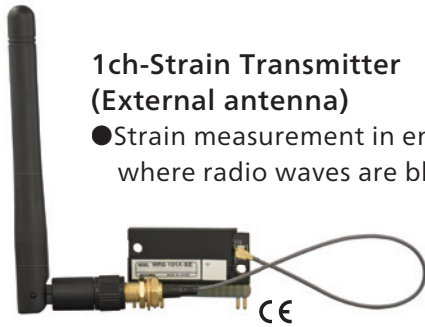

1ch-Strain Transmitter MRS-101A-SE (External antenna)

- Strain measurement in environments where radio waves are blocked



1ch-Voltage Transmitter MRS-101A-V

- Moving object voltage measurement

Strain gages (Quarter-bridge 2-wire system, and full-bridge system), strain-gage transducer (For quarter bridge 2-wire system, the adapter 1G2W is required)	Voltage
1	
-	Approx. 1 MΩ +1 MΩ
120 to 1000 Ω	-
2.00 fixed	-
1 VDC	-
-	Between D (+IN) and B (-IN): Within ±32 V Between D and E (SHIELD): Within ±16 V Between B and E: Within ±16 V * Exceeding the Absolute Input Voltage may cause permanent damage to the product.
1000, 2500, 5000, 10000, 25000 × 10 ⁻⁶ strain	5, 10 V
Within ±10000 × 10 ⁻⁶ strain	Within ±0.15% FS
	Within ±5 V
	16 bits
	4.8 kHz
Zero point: Within ±0.05 × 10 ⁻⁶ strain per °C Sensitivity: Within ±0.01%/°C	Zero point: Within ±0.01% FS per °C Sensitivity: Within ±0.02%/°C
-25 to 75 °C	
20 to 85% (Non-condensing)	
29.42 m/s ² (3 G), 5 to 200 Hz	294.2 m/s ² (30 G), 10 to 500 Hz
294.2 m/s ² (30 G), 11 ms	980.7 m/s ² (100 G), 11ms
-	29420 m/s ² (3000 G)
2.2 to 4.4 VDC	
Within 32 mA (Test conditions: Power supply 3.0 V, bridge resistance 120 Ω)	Within 22 mA
Approx. 28 h [Lithium (CR2 manufactured by Panasonic)] Approx. 24 h [Ni-MH eneloop® (BK-4MCC, AAA cell × 2)] Approx. 34 h [Alkaline EVOLTA (LR03EJ, AAA cell × 2)] *Under the test conditions: 23 °C, bridge resistance 120 Ω	Approx. 38 h [Lithium (CR2 manufactured by Panasonic)] Approx. 33 h [Ni-MH eneloop® (BK-4MCC, AAA cell × 2)] Approx. 49 h [Alkaline EVOLTA (LR03EJ, AAA cell × 2)] *Under the test conditions: 23 °C
Approx. 10 g	
Directive 2014/53/EU (RED) Directive 2011/65/EU (6 restricted substances) (RoHS)	

1ch-Strain Transmitter MRS-101A-SE

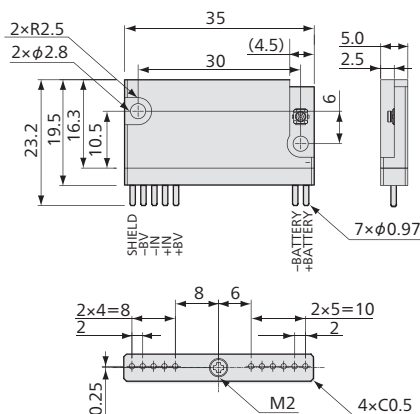

1ch-Voltage Transmitter MRS-101A-V

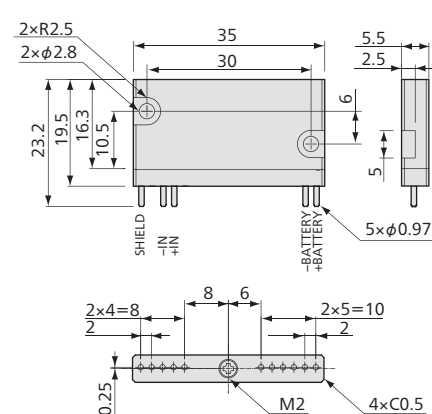

Standard Accessories

MRS-101A-SE: Adapter board ADP-01, JCIS10-70 miniature screw (M2 × 4) × 1.

The above are installed in the transmitter. Battery holder (AAA cell × 2) for checking operation, ID label, receiving antenna W1030, antenna harness

MRS-101A-V: Voltage adapter ADP-03, JCIS10-70 miniature screw (M2 × 4) × 1.

The above are installed in the transmitter. Battery holder (AAA cell × 2) for checking operation, ID label

Receiver lineup

4ch-Receiver MRS-114A
 ● Usable in EU
 ● Usable in Japan, the USA, India, and Thailand



MRS-114A

1ch-Receiver MRS-111A
 ● Usable in Japan, the USA, India, and Thailand



MRS-111A

1ch-Receiver MRS-111A-E
 ● Usable in EU
 ● Usable in Japan, the USA, India, and Thailand



MRS-111A-E

	MRS-114A	MRS-111A, MRS-111A-E
Channels	4	1
Analog Output Accuracy	Within $\pm 0.1\%$ FS	
DA Resolution	16 bits	
DA Conversion Speed	1 channel: 4.8 kHz, 2 channels: 3.2 kHz, 3 channels: 2.4 kHz, 4 channels: 1.92 kHz	4.8 kHz
Operating Temperature	0 to 50 °C	
Operating Humidity	20 to 80% (Non-condensing)	
Vibration Resistance	29.42 m/s ² (3G), 5 to 200 Hz	
Shock Resistance	294.2 m/s ² (30 G), 11 ms	
Power Supply	10 to 16 VDC	
Current Consumption	280 mA or less	250 mA or less
Operating Switch	MUTE: Turn buzzer on/off. BAL: Execute balance adjustment. CHECK: Check sensor connection. START: Start measurement. STOP: Stop measurement. Tx OFF: Turn transmitter off. SLEEP: Set transmitter to sleep, wake-up after the set time.	
Indicator	Monitor transmitter battery in 3 steps. Monitor received signal strength in 3 steps. 7-segment LED: Indicate a frequency channel (0 to F) DATA: Light up in response to radio communication error/non-error. LOCK: Light up to indicate keys are locked.	
Weight	Approx. 600 g	
Compliance	MRS-114A, MRS-111A-E: Directive 2014/53/EU (RED) MRS-114A: Directive 2011/65/EU, (EU)2015/863 (10 restricted substances) (RoHS) MRS-111A, MRS-111A-E: Directive 2011/65/EU (6 restricted substances) (RoHS)	

1ch-Receiver MRS-111A
 MRS-111A-E is the same in dimension.

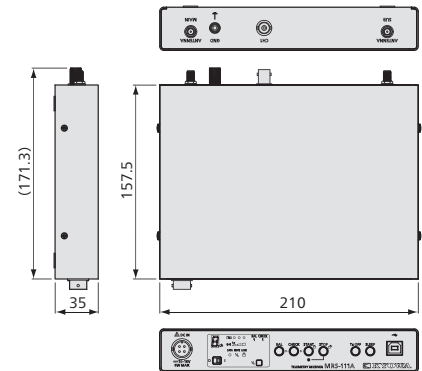

4ch-Receiver MRS-114A

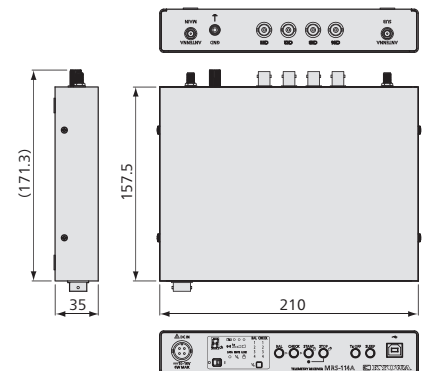

RF Specifications

Transceiver Frequency Channel	1 (Choose 1 channel from 16 channels using Setting software)
Antennas	MRS-104A-S, MRS-101A-S, MRS-101A-V: Built-in MRS-101A-SE, MRS-114A, MRS-111A, MRS-111A-E: Specified external (MAIN and SUB for diversity reception.)
Radio Communication Frequency Band	2.4 GHz band
Radio System	Digital modulation system
Radio Certification	MRS-104A-S, MRS-101A-S, MRS-101A-SE, MRS-101A-V, MRS-114A, MRS-111A-E: Japan, the USA, India, Thailand, EU MRS-111A: Japan, the USA, India, Thailand
Communication Distance	50 m (Max. line of sight distance) For MRS-101A-SE, using attached receiving antennas W1030.
Environment of Usage	Environment where the wireless LAN is not intermingled on the 2.4 GHz.

Frequency Channel and Central Frequency

Frequency Channel	CH 0	CH 1	CH 2	CH 3	CH 4	CH 5	CH 6	CH 7
Central Frequency (GHz)	2.405	2.410	2.415	2.420	2.425	2.430	2.435	2.440
Frequency Channel	CH 8	CH 9	CH A	CH B	CH C	CH D	CH E	CH F
Central Frequency (GHz)	2.445	2.450	2.455	2.460	2.465	2.470	2.475	2.480

Communication is not possible if there are multiple transmitters with the same radio channels in the system.

With antennas W1030
 MRS-111A
 MRS-114A is the same in dimension.

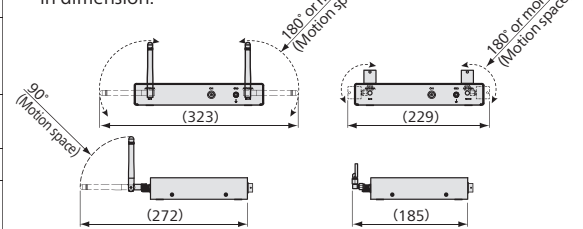

Standard Accessories

- MRS-114A, MRS-111A, MRS-111A-E
 USB cable N-38 (1 m), BNC-BNC cable U-59 (Each channel, 1.5 m), ground wire P-72 (5 m), side hole suction cup (55 mm) × 2, extension cable for receiving antenna (2 m) E-02 × 2
- MRS-114A
 Setting software MRS-10B, AC adapter (AC power cable sold separately. Select according to your country or region), receiving antenna W1030 × 2, high gain dipole antenna DA-DB-05RP-SMA-08 × 2
- MRS-111A:
 Setting software MRS-10A, AC adapter UNI318-1215-EDS, receiving antenna W1030 × 2
- MRS-111A-E
 Setting software MRS-10A, AC adapter UNI318-1215-EDS (for EU), small planar antenna EXT-ANT1 × 2, SMA straight connector (Reverse) × 2, SMA right angle connector (Reverse) × 2

Specifications in Combination with Transmitter and Receiver

Analog Output Voltage	±5 V/Full scale range
Accuracy	Within ±0.2% FS

Frequency Response and Delay Time

Measuring Channels	Sampling Frequencies	Frequency Response	Delay Time
1	4.8 kHz	DC to 370 Hz (Deviation+0.5, -1 dB) -3±1 dB (at 480 Hz)	11.1±0.3 ms (at DC to 480 Hz)
2	3.2 kHz	DC to 320 Hz (Deviation+0.5, -1 dB) -3±1 dB (at 466 Hz)	10.8±0.3 ms (at DC to 320 Hz)
3	2.4 kHz	DC to 240 Hz (Deviation+0.5, -1 dB) -3±1 dB (at 424 Hz)	9.8±0.3 ms (at DC to 240 Hz)
4	1.92 kHz	DC to 192 Hz (Deviation+0.5, -1 dB) -3±1 dB (at 376 Hz)	9.7±0.3 ms (at DC to 192 Hz)















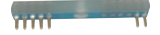

Only 1 transmitter can be used in combination with 1 receiver.
 No MRS-104A-S be used in combination with a 1-channel Receiver.
 2 or more measuring channels are for 4-channel transmitter and 4-channel receiver.
 The frequency response is DC to 480 Hz for the combination 1-channel Transmitter with 1-channel Receiver.

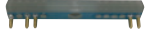
Optional Accessories

Setting Software MRS-10A, MRS-10B Specifications

■ Applicable Receivers	
	MRS-10A: MRS-111A, MRS-111A-E MRS-10B: MRS-114A, MRS-111A, MRS-111A-E
■ Software Functions	
Setting Functions	Set the measuring range.
	Set the LEDs lighting level for monitoring transmitter supply voltage.
	Set the minimum voltage for operating transmitter.
	Set frequency channel.
Operation Functions	Set the sleep time of transmitter.
	Set data processing at the time of radio communication error.
	Execute balance adjustment.
Inspection Function	Check sensor connection. Display graph.
	Radio condition inspection
■ Operating Environment	
OS	Windows® 7, Windows® 8, 8.1, Windows® 10 (Japanese/English, 32/64 bit support)
CPU	Core2Duo, 2 GHz or advanced
Memory	4 GB or more
Interface	USB2.0 (Can also be operated in a USB3.0 port)
Display	Resolution: 1024 × 768 or more

There is no data acquisition function by this software.

Package for transmitter			Adapters		
					
MRS package kit	MRS transmitter unit (CR2)	Full-bridge adapter	Quarter-bridge 2-wire adapter (120 Ω)	Quarter-bridge 3-wire adapter (120 Ω)	
MRS-P11A	MRS-J11A	ADP-401	ADP-402-120	ADP-403-120	
For MRS-101A-SE It is easy to attach batteries, connect antennas, a sensor, and the power supply can be turned on and off. Applicable batteries: 2 AAA nickel-metal hydride batteries, 2 AAA alkaline batteries	For MRS-101A-S/SE/V It is easy to attach a battery, connect antennas, a sensor, and the power supply can be turned on and off. Applicable batteries: 1 lithium battery CR2	For MRS-104A-S 2 channels/pc Connect to strain-gage transducers	For MRS-104A-S 2 channels/pc Connect to quarter-bridge 2-wire 120 Ω strain gages	For MRS-104A-S 2 channels/pc Connect to quarter-bridge 3-wire 120 Ω strain gages	
Adapters			Antennas		
					
Power adapter	Adapter board	Quarter-bridge 2-wire adapter (120 Ω)	Voltage adapter	High gain dipole antenna	
ADP-40P	ADP-01	ADP-02-120	ADP-03	DA-DB-05RP-SMA-08	
For MRS-104A-S Connect to a DC power supply (2.2 to 4.4 VDC)	For MRS-101A-S/SE Connect to a full-bridge strain gage or a strain-gage transducer	For MRS-101A-S/SE Connect to a quarter-bridge 2-wire 120 Ω strain gage	For MRS-101A-V Connect to voltage or a voltage-output sensor	For MRS-114A, MRS-111A High sensitivity and improved communication stability	
Antennas		Cables			
					
Small planar antenna	Planar diversity antenna	Extension cable for receiving antenna (2 m)	Extension cable for receiving antenna (6 m)	DC power cable	AC power cable
EXT-ANT1	EXT-ANT2	E-02	E-03	P-76	P-38 to P-42
For MRS-100 Series Thin, high gain, and therefore effective for narrow spaces	For MRS-114A, MRS-111A Supports two orthogonal polarization planes—vertical and horizontal polarization—by using the polarization diversity method*	For MRS-101A-SE, MRS-114A, MRS-111A (-E) This approx. 2-m cable can be used to more flexibly position an antenna.	For MRS-101A-SE, MRS-114A, MRS-111A (-E) This approx. 6-m cable can be used to more flexibly position an antenna. However, the cable is not compliant with EU directives.	For power supply to MRS-114A or MRS-111A(-E) Length: Approx. 2 m	P-38 (Japan), P-39 (the USA), P-40 (India), P-41 (EU), P-42 (Thailand)

* Diversity reception suitable for multi-path can be made with one antenna.

This small, thin antenna is suitable for incorporation. Because the back of the main unit is hardly affected by structural objects, it can be directly attached to the wall or the like.
 Its waterproof structure allows the antenna to be installed outdoors. However, note that the connector is not waterproof.

Optional Accessories Selection Chart

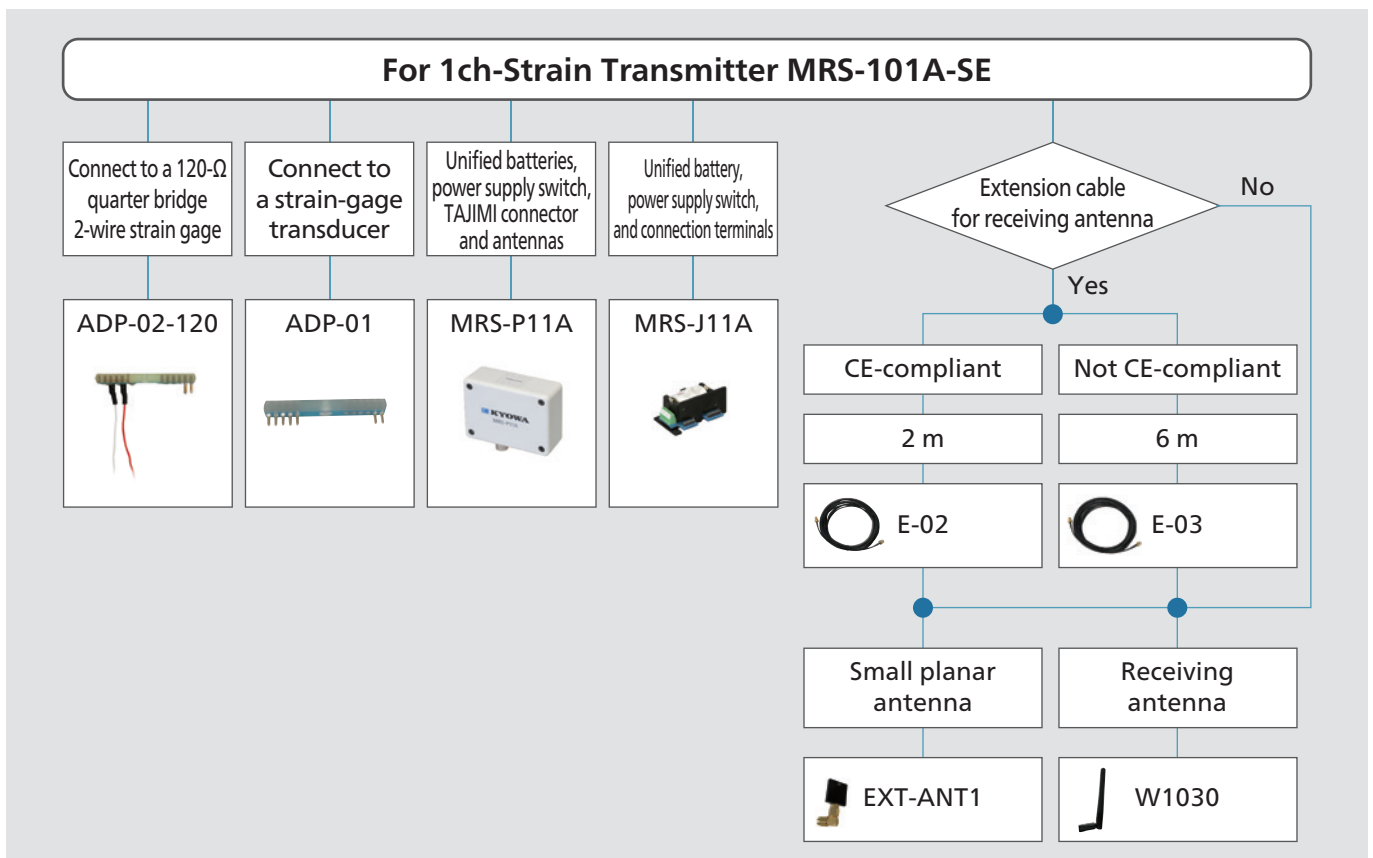
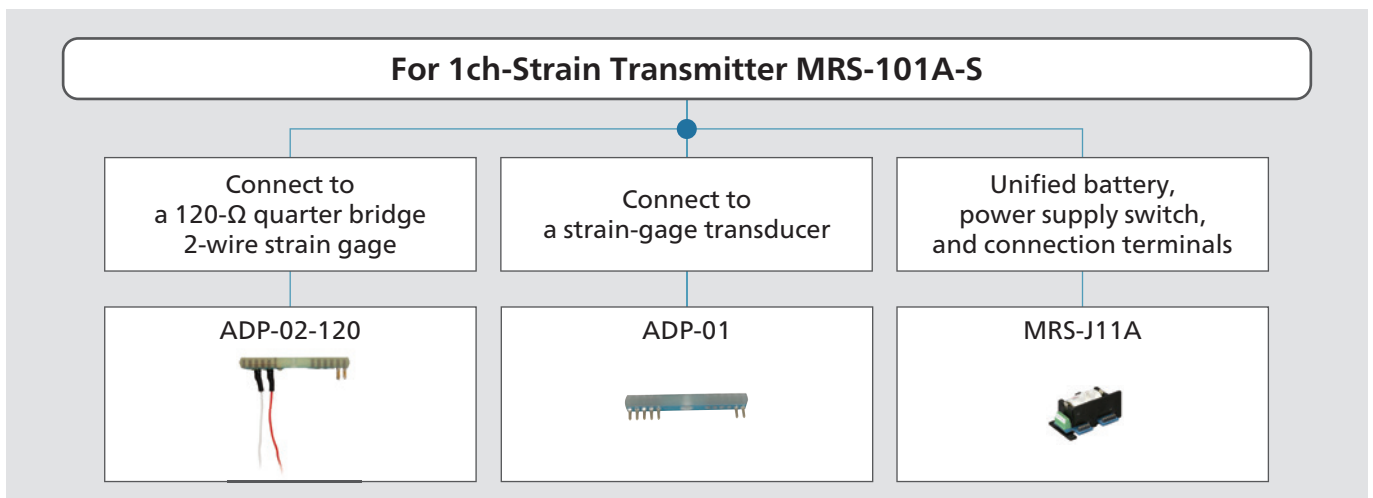
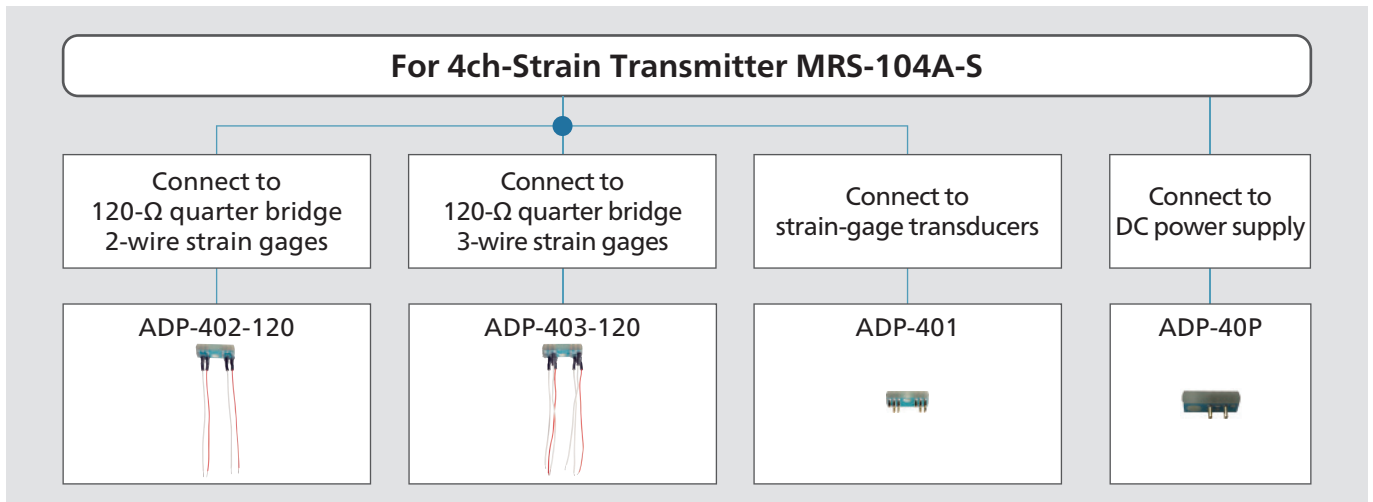

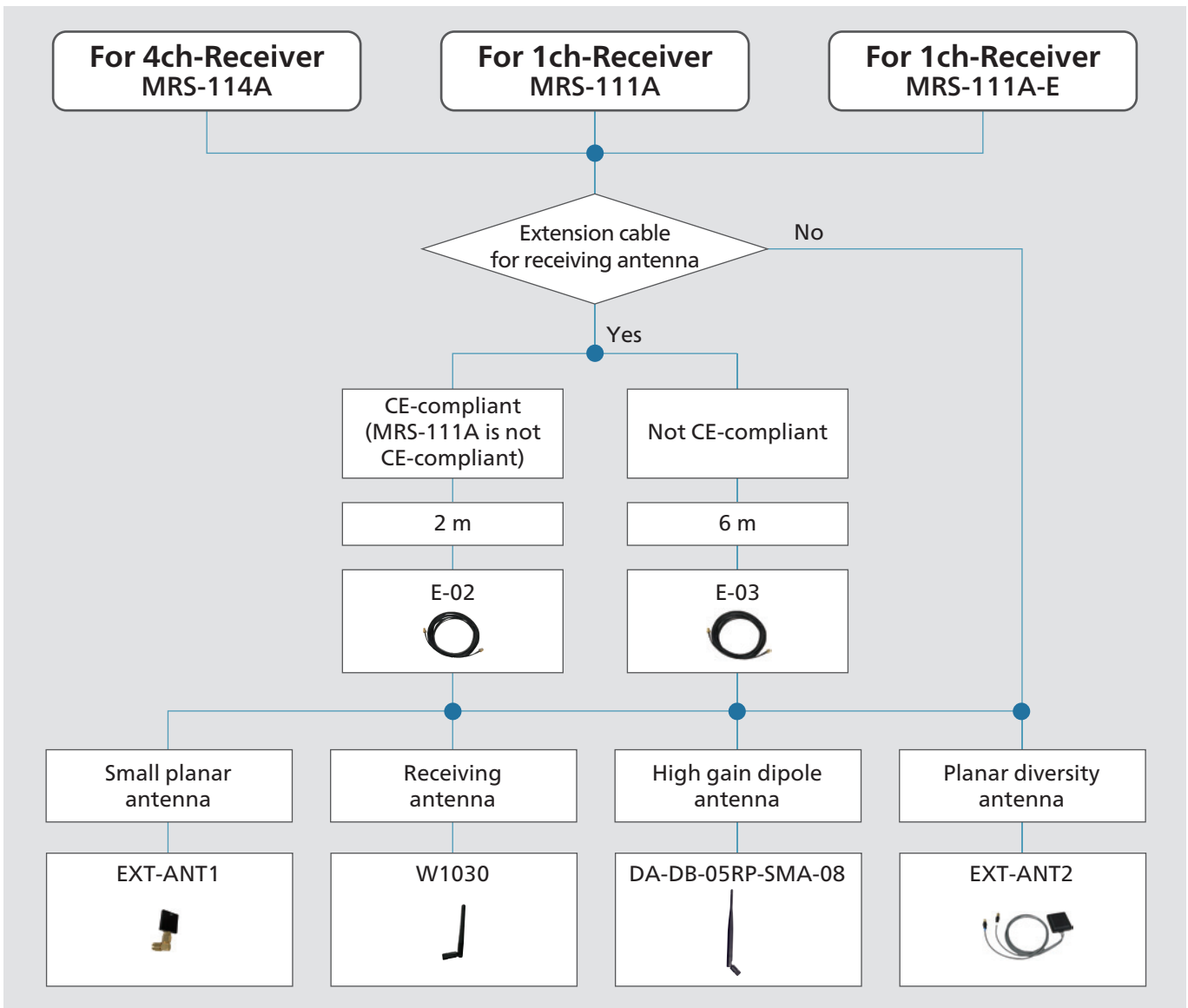
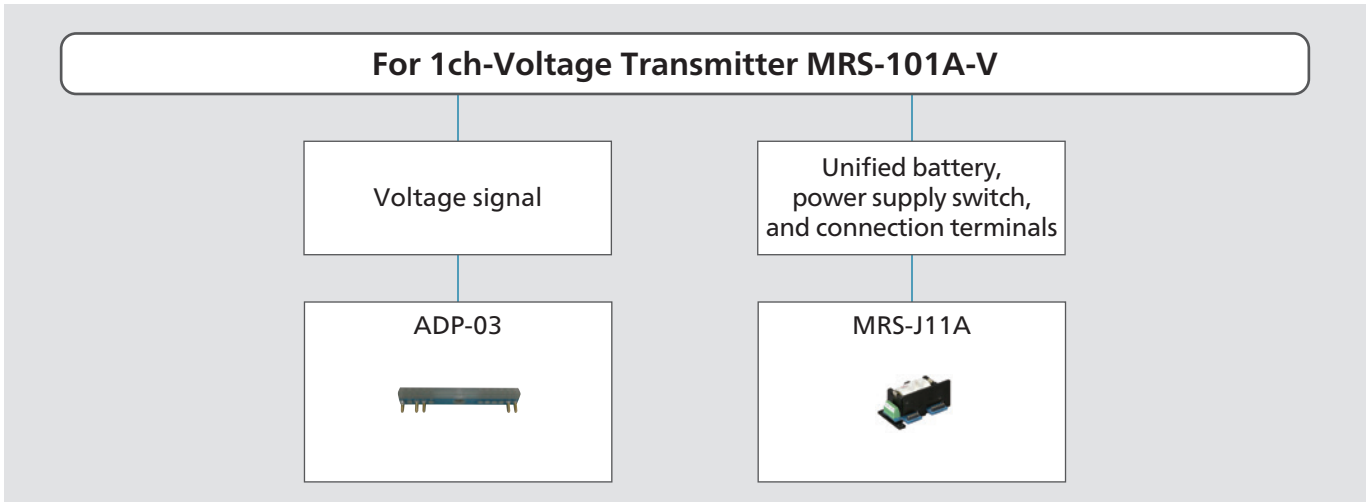

Combine MRS-114A with Transmitters

1. Each receiver can only be combined with one transmitter.
2. Transmitters and receivers can only communicate at the same radio frequency.
3. Communication is not possible if there are multiple transmitters with the same radio channels in the system.

Combination examples

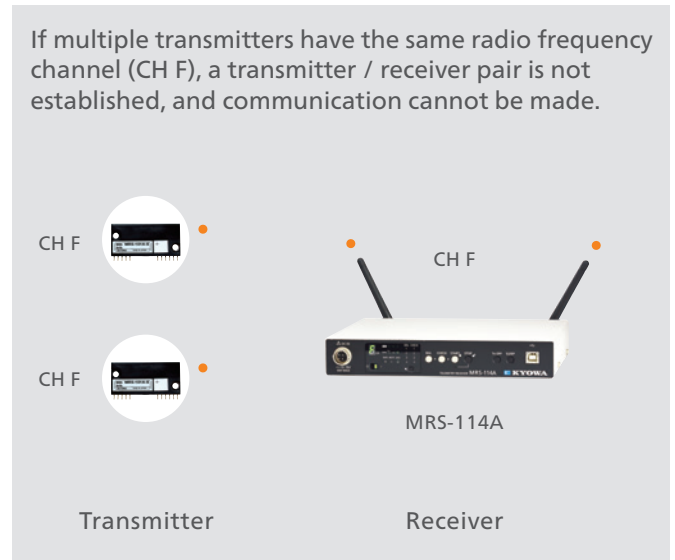
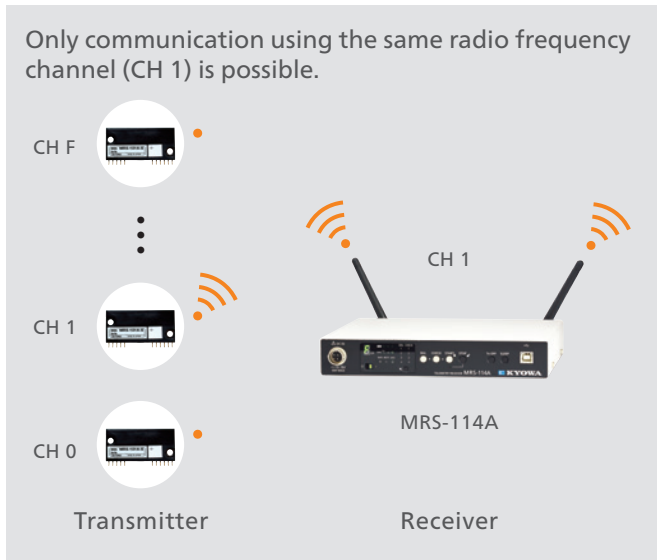

Sales Network



Other Countries or Regions

Please visit below URL.
Website: www.kyowa-ei.com

Americas Region

KYOWA AMERICAS Inc.
TEL: +1-248-348-0348
E-mail: sales@kyowa-americas.com
Website: www.kyowa-ei.us

China

KYOWA ELECTRONIC (SHANGHAI) TRADING CO., LTD.
TEL: +86-21-64477770
E-mail: support-cn@d1.kyowa-ei.co.jp
Website: www.kyowa-ei.cn

Thailand

KYOWA DENGYO (THAILAND) CO., LTD.
TEL: +66-2-117-3760
E-mail: sales-thailand@kyowa-ei.co.th
Website: www.kyowa-ei.th

India

KYOWA ELECTRONIC INSTRUMENTS CO.,LTD. (India Branch)
TEL: +91-124-427-7227
Website: www.kyowa-ei.com

Kyowa Electronic Instruments Co., Ltd.

Overseas Sales Department:
3-5-1, Chofugaoka, Chofu, Tokyo 182-8520 Japan
TEL; +81-42-489-7220 FAX: +81-42-488-1122
E-mail: kyowaoverseas.hp@d1.kyowa-ei.co.jp
Website: www.kyowa-ei.com



Safety Precautions

Be sure to observe the safety precautions given in the instruction manual, in order to ensure correct and safe operation.

- Specifications are subject to change without notice for improvement.



JQA-0821
JQA-EM4824

Manufacturer's Representative