

SHN900A Series Vector Network Analyzer

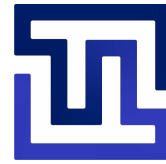

INSTRUMENTS
**TECHNO
TEST**

Data Sheet
EN02C



SIGLENT TECHNOLOGIES CO., LTD.

SHN900A

General Description

The SIGLENT SHN900A series of Vector Network Analyzers have a frequency range of 30 kHz to 26.5 GHz, which support 2-port scattering parameter, differential-parameter, and time-domain parameter measurements. The SHN900A series of VNAs are effective instrumentation for determining the Q-factor, bandwidth, and insertion loss of a filter, the feature impedance conversion, movement of measurement plane, limit testing, ripple test, fixture simulation, and adapter removal/insertion adjustments. The VNAs have five sweep types: Linear-Frequency mode, Log-Frequency mode, Power-Sweep mode, CW-Time mode, and Segment-Sweep mode. The SHN900A series VNAs also support scattering-parameter correction of SOLT, SOLR, TRL, Response, and Enhanced Response for increased flexibility in R&D and manufacturing applications.

Key Features

- Frequency range: 30 kHz - 26.5 GHz
- Frequency resolution: 1 Hz
- Level resolution: 0.05 dB
- Range of IFBW: 10 Hz~3 MHz
- Setting range of output level: -45 dBm ~ +10 dBm
- Dynamic range: 110 dB (Typ.)
- Types of calibration: Response calibration, Enhanced Response calibration, Full-one port calibration, Full-two port calibration, TRL calibration
- Types of measurement: Scattering-parameter measurement, differential-parameter measurement, receiver measurement, time-domain parameter analysis, limit test, ripple test, impedance conversion, fixture simulation, adapter removal/insertion, spectrum analysis frequency offset, scalar mixer measurement, pulse measurement
- Internal Bias-Tee connections
- Support GPS, Time and Location Information Saving
- Interface: LAN, USB Device, USB Host (USB-GPIB)
- Remote control: SCPI/ Labview/ IVI based on USB-TMC / VXI-11 / Socket /Telnet / WebServer
- 8.4-inch touch screen, Mouse, Keyboard



Models and Key Specifications

Model	SHN914A	SHN920A	SHN926A
Frequency range	30 kHz - 14 GHz	30 kHz - 20 GHz	30 kHz - 26.5 GHz
Ports	2		
Frequency resolution	1 Hz		
Level resolution	0.05 dB		
Range of IFBW	10 Hz ~ 3 MHz		
Setting range of output level	-45 dBm ~ +10 dBm		
Dynamic range	110 dB (Typ.)		
Types of calibration	Response calibration, Enhanced Response calibration, Full-one port calibration, Full-two port calibration, TRL calibration		
Types of measurement	Scattering-parameter measurement, differential-parameter measurement, receiver measurement, time-domain parameter analysis, limit test, ripple test, impedance conversion, fixture simulation, adapter removal/insertion, enhanced time-domain parameter analysis (TDR), spectrum analysis, frequency offset, scalar mixer measurement, pulse measurement		
Bias-Tees	Support		
Interface	LAN, USB Device, USB Host (USB-GPIB)		
Remote control	SCPI/ Labview/ IVI based on USB-TMC/ VXI-11/ Socket/ Telnet/ WebServer		
Display	8.4-inch touch screen		
GPS	Support		

Design Features

Multi-window display:

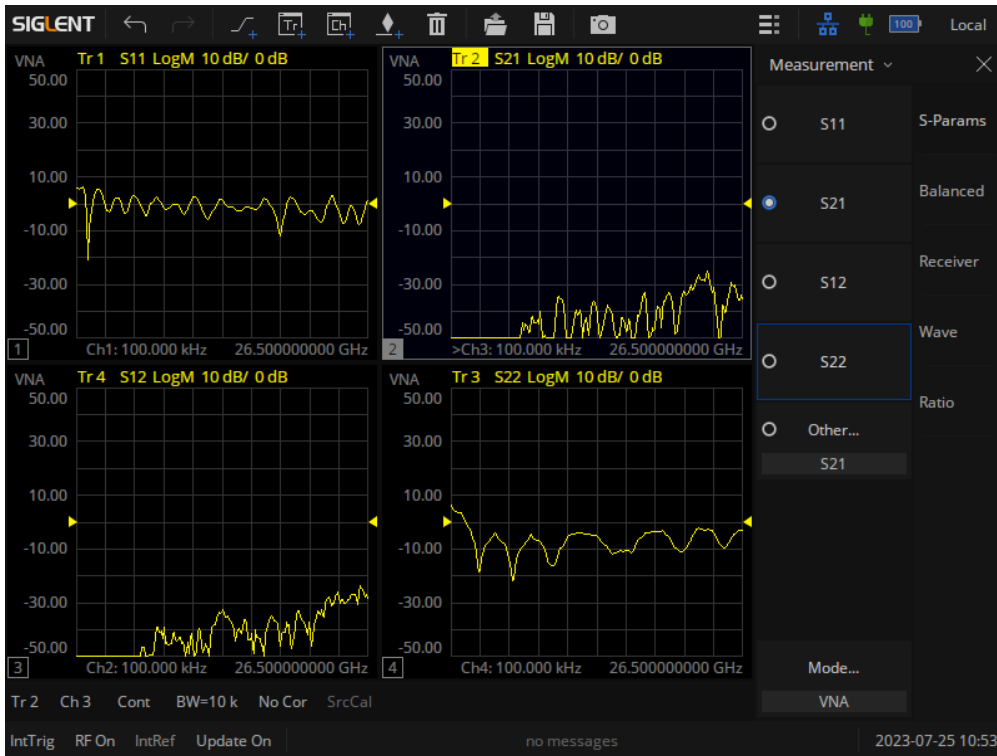

Multi-format display:

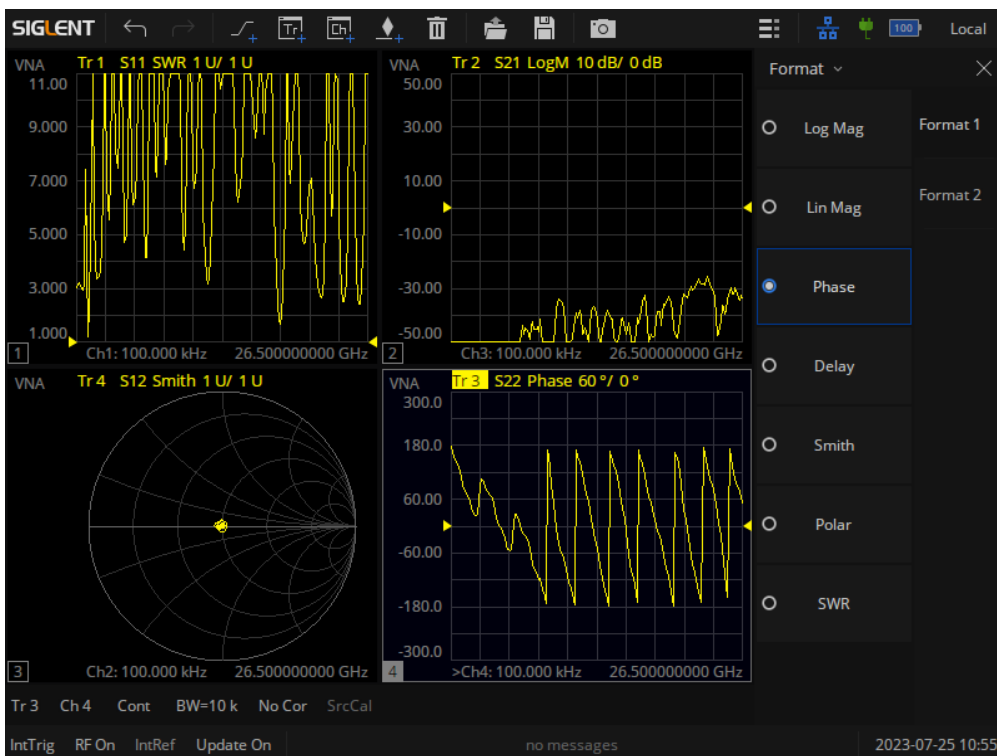

Display and compare memory and current data:

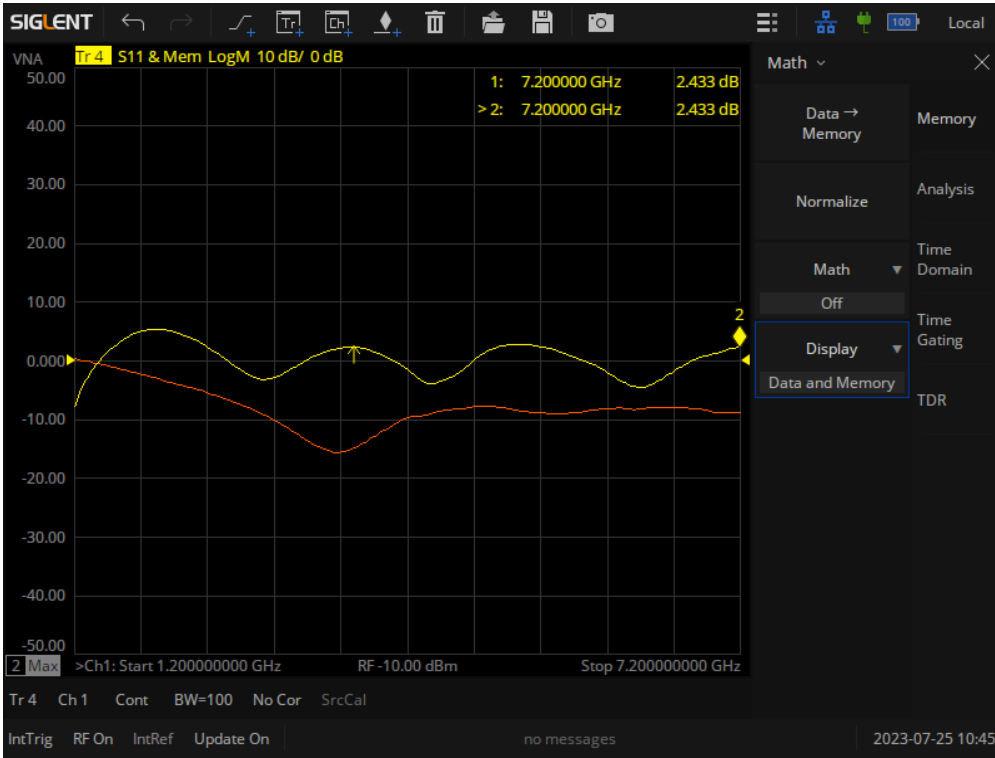

Display data hold:

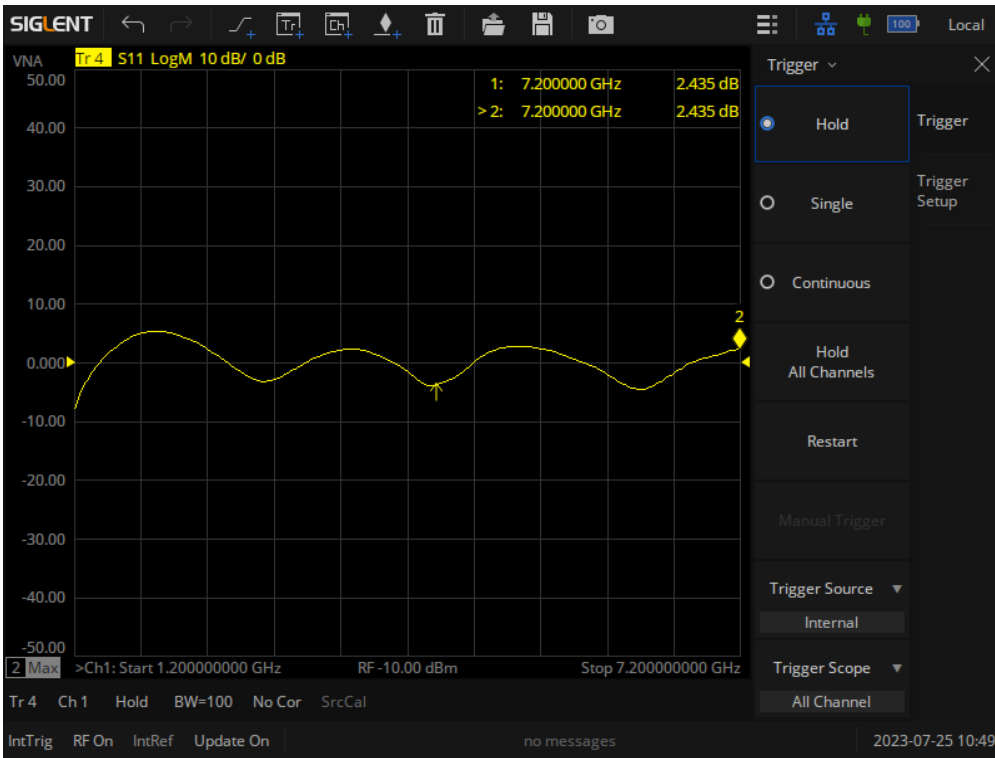

Impedance conversion:



Equation Editor:

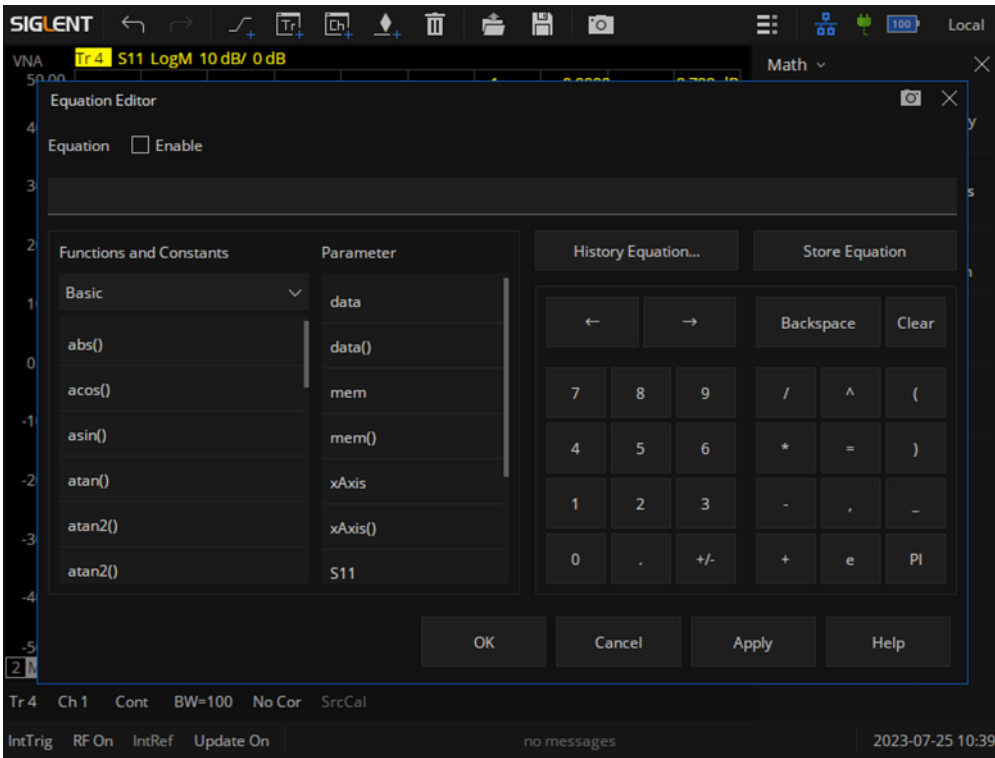

Port Extensions:

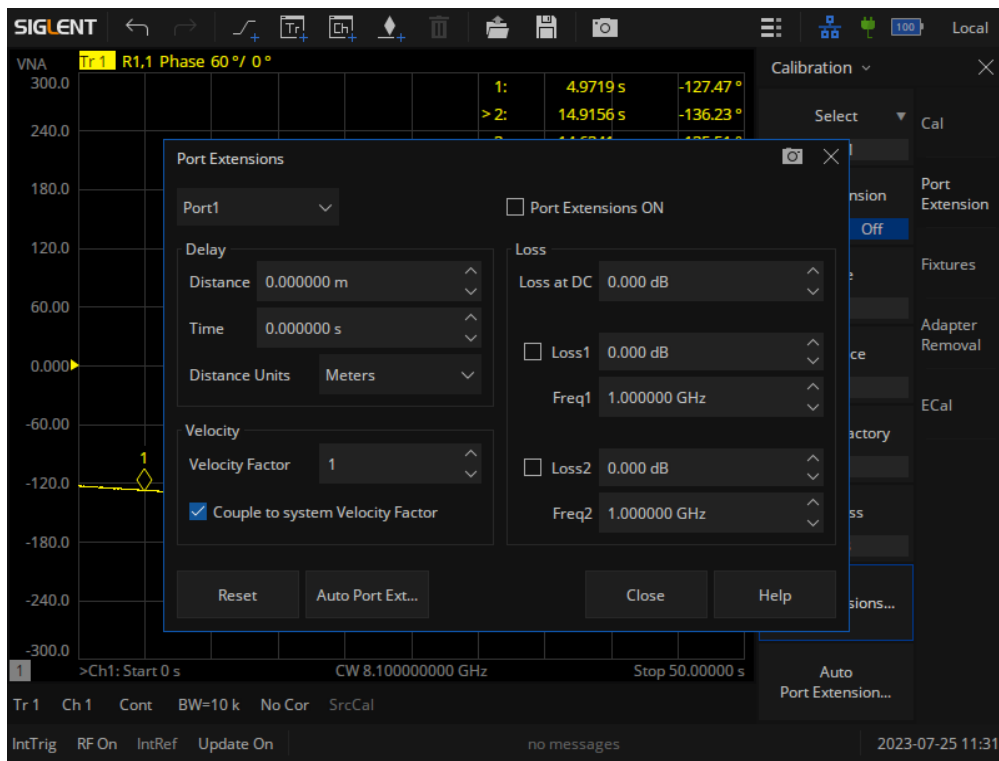

Embedding and De-Embedding:

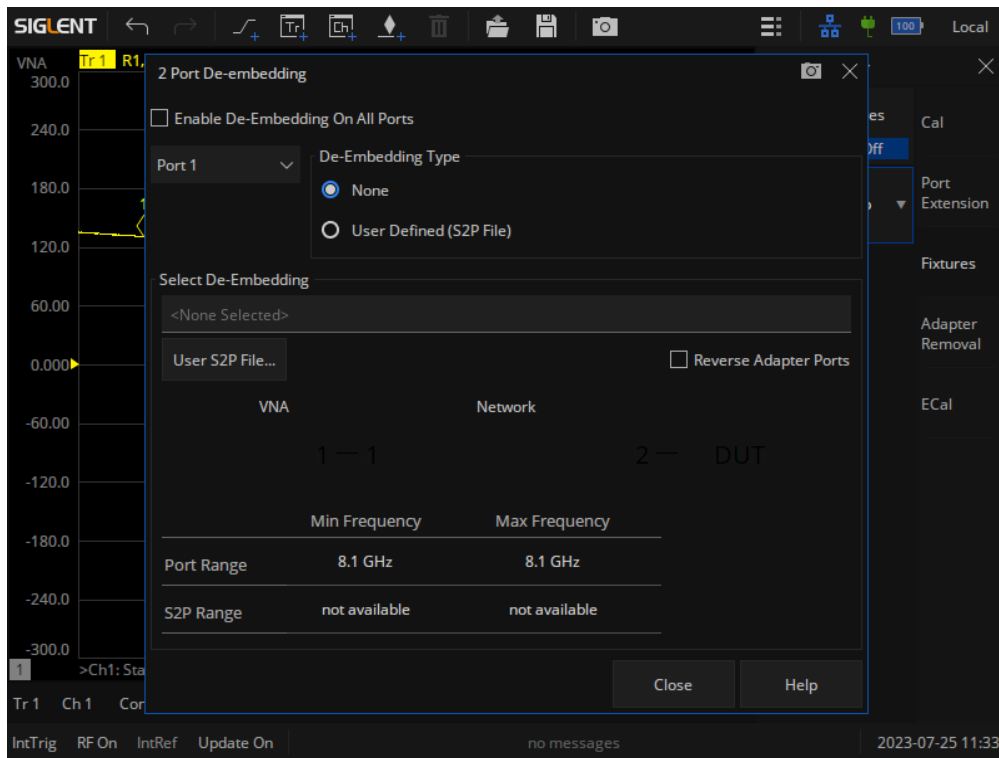

CAT:

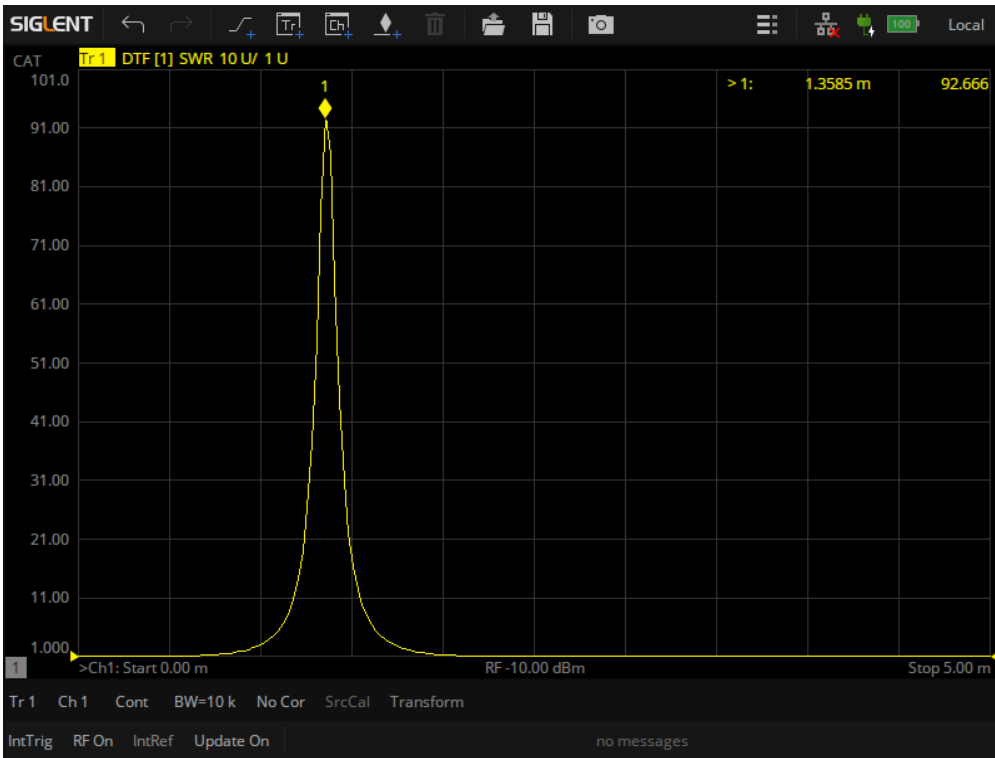

Time-Domain analysis:

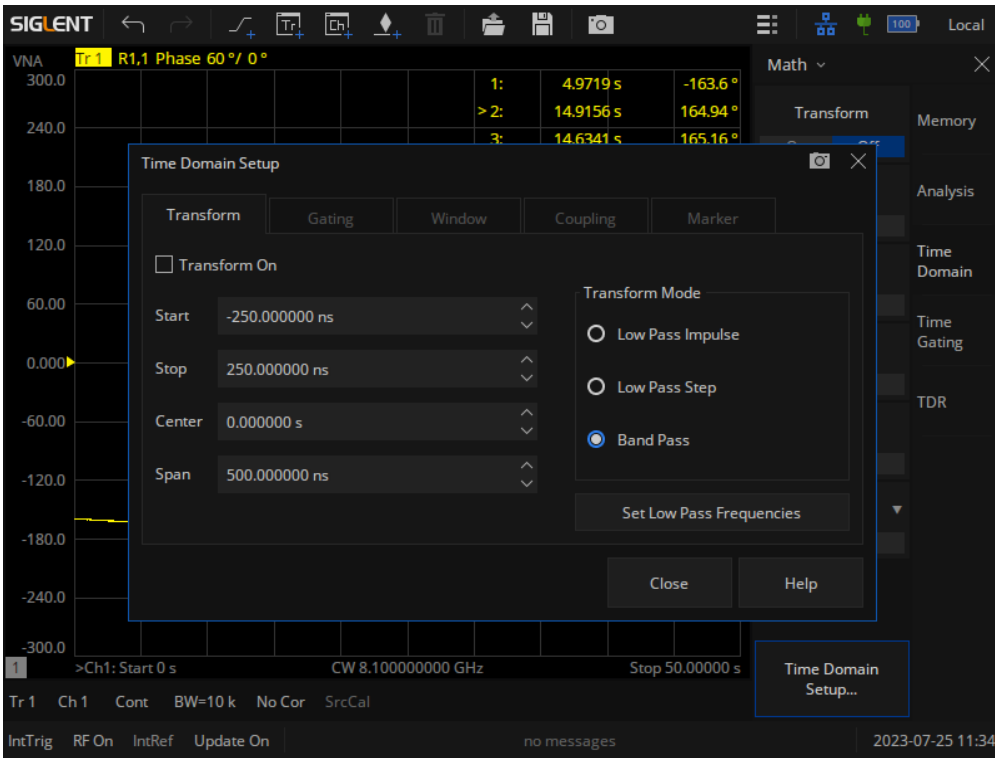

Enhanced Time-Domain analysis(TDR):



Spectrum analysis:

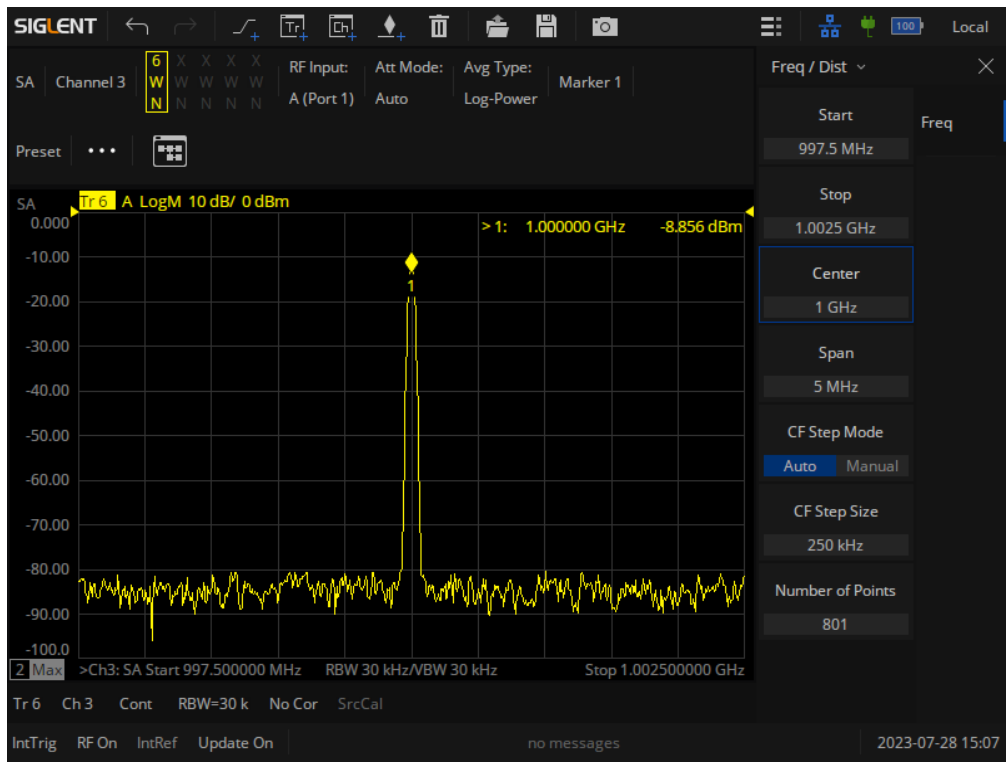

Automatic fixture removal function(SHN900-AFR option)

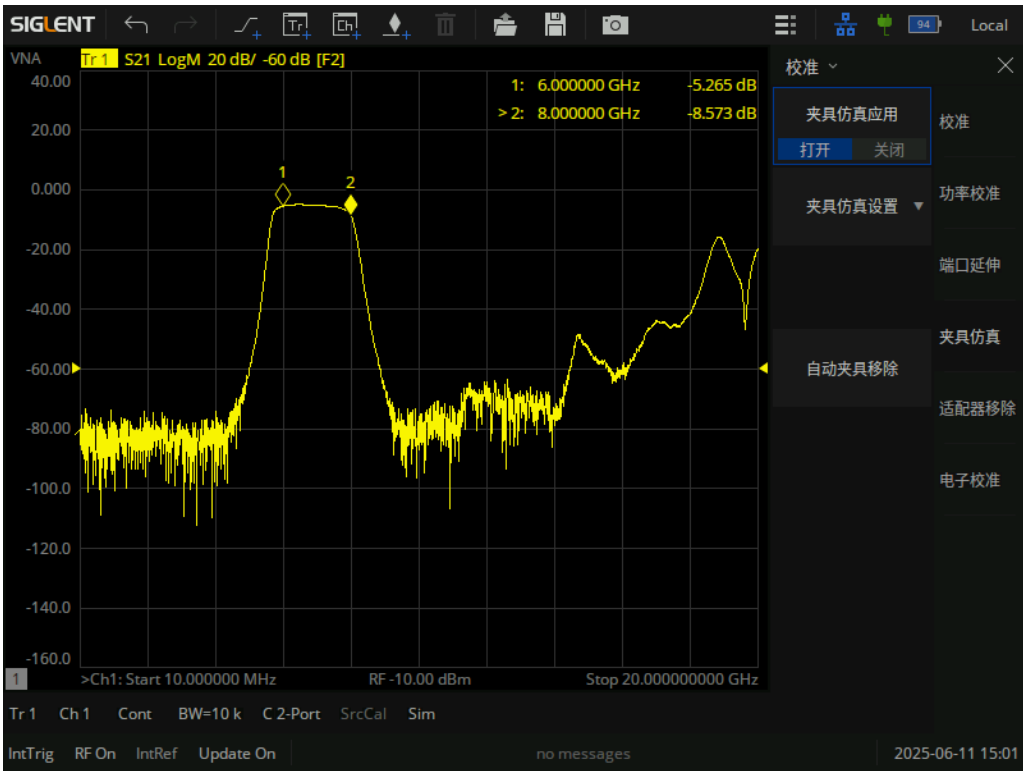

Definitions

Specifications are valid under the following conditions: The instrument is within the calibration period, has been stored between 0 and 40 °C for at least 2 hours before use, and has been powered on and warmed up for at least 90 minutes. The specifications include the measurement uncertainty unless otherwise noted.

Specifications: All products are guaranteed to meet published specifications at room temperature (approximately 25 °C), unless otherwise noted.

Typical: Performance deemed typical implies that 80 percent of the measurement results will meet the typical published performance with a 95th percentile confidence level at room temperature (approximately 25 °C). Typical performance is not warranted and does not include measurement uncertainty.

Nominal: This value indicates the expected mean or average performance, or an attribute whose performance is by design, such as the 50 Ohm connector.

Specifications

Dynamic range

Frequency Range	IFBW	Specification (dB)	Typical (dB)
30 kHz - 50 kHz	10 Hz	60	70
50 kHz - 200 kHz		80	100
200 kHz - 6.2 GHz		100	120
6.2 GHz - 9 GHz ¹		100	105
9 GHz - 20 GHz		100	115
20 GHz - 26.5 GHz		70	100

(1) Some special frequencies will degrade

Corrected system performance with calibration kit

User correction: On, system correction: On; Corrected system performance with Keysight 85052D 3.5mm calibration kit, isolation calibration performed. IFBW is 10 Hz, no averaging applied to data, and environmental temperature is 25°C (± 5°C), with <1°C deviation from calibration temperature.

Specification (dB)	30 kHz-3 GHz	3 GHz-6 GHz	6 GHz-14 GHz	14 GHz-20 GHz	14 GHz-26.5 GHz
Directivity	41	38	32	30	30
Source match	38	32	30	30	28
Load match	42	38	35	32	30
Reflect tracking	±0.02	±0.06	±0.07	±0.08	±0.1

Transmission tracking	± 0.1	± 0.15	± 0.25	± 0.3	± 0.51
-----------------------	-----------	------------	------------	-----------	------------

Reflection uncertainty (Specification, Power: -10 dBm, IFBW:10 Hz):

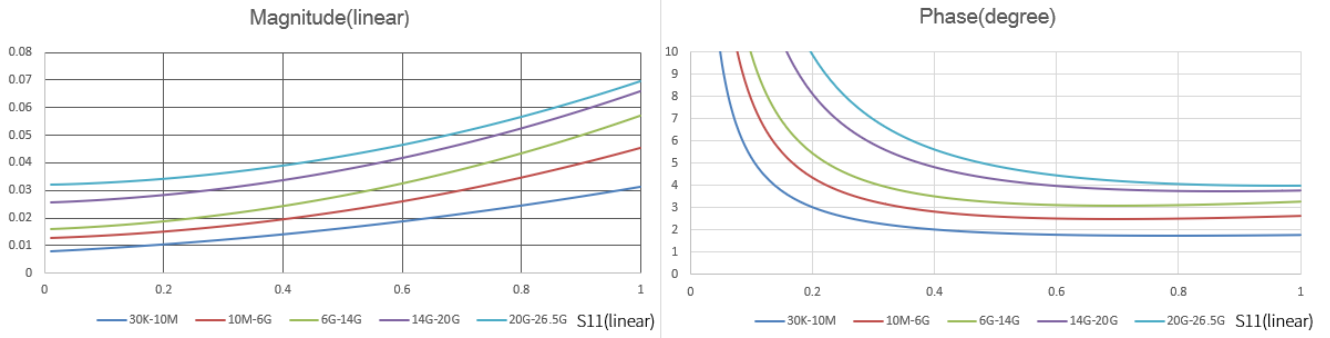

Transmission uncertainty (Specification, Power: -10 dBm, IFBW:10 Hz):

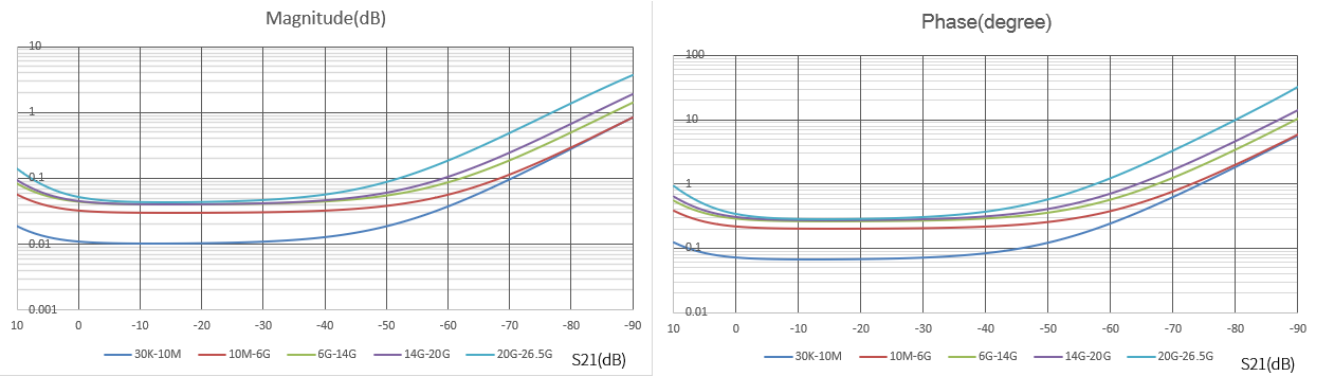

Uncorrected system performance

User correction: Off, system correction: On; IFBW is 10 Hz, no averaging applied to data.

Specification (dB)	30 kHz – 300 kHz	300 kHz - 1 GHz	1 GHz-6 GHz	6 GHz-26.5 GHz
Directivity	15	20	25	20
Source match	20	25	25	20
Load match	6	6	12	7
Reflect tracking	±1.0	±1.0	±1.0	±1.0
Transmission tracking	±1.0	±1.0	±1.0	±1.0

Test port output (Source)

Test port output frequency

Description	Specification
Frequency range	
SHN914A	30 kHz to 14 GHz
SHN920A	30 kHz to 20 GHz
SHN926A	30 kHz to 26.5 GHz
Frequency resolution	1 Hz
CW accuracy	
Standard	± 5.0 ppm (23 ± 3 °C)
Source stability	
Standard	± 5.0 ppm (0 to 40 °C) ± 0.5 ppm/year, ± 3.0 ppm/20 year

Test port output power

Description	Specification
Preset power	-10 dBm
Level accuracy	± 2 dB@-10 dBm 30kHz ~ 20GHz ± 2.5 dB@-10 dBm 20GHz ~ 26.5GHz
Level linearity	
30 kHz - 100 kHz	± 1 dB (-20 dBm to -11 dBm)
100 kHz - 25 MHz	± 1 dB (-20 dBm to -5 dBm)
25 MHz - 14 GHz	± 1 dB (-20 dBm to -1 dBm)
14 GHz - 20 GHz	± 1 dB (-20 dBm to -4 dBm)
20 GHz - 24 GHz	± 2 dB (-20 dBm to -6 dBm)
24 GHz - 26.5 GHz	± 2 dB (-20 dBm to -8 dBm)
Range	
30 kHz - 100 kHz	-45 dBm to -11 dBm
100 kHz - 25 MHz	-45 dBm to -5 dBm
25 MHz - 14 GHz	-45 dBm to -1 dBm
14 GHz - 20 GHz	-45 dBm to -4 dBm
20 GHz - 24 GHz	-45 dBm to -6 dBm

24 GHz - 26.5 GHz	-45 dBm to -8 dBm
Sweep range	
30 kHz - 100 kHz	-45 dBm to -11 dBm
100 kHz - 25 MHz	-45 dBm to -5 dBm
25 MHz - 14 GHz	-45 dBm to -1 dBm
14 GHz - 20 GHz	-45 dBm to -4 dBm
20 GHz - 24 GHz	-45 dBm to -6 dBm
24 GHz - 26.5 GHz	-45 dBm to -8 dBm
Max leveled power	
30 kHz - 100 kHz	-11 dBm (Typ.)
100 kHz - 25 MHz	-4 dBm (Typ.)
25 MHz - 100 MHz	0 dBm (Typ.)
100 MHz - 6 GHz	2 dBm (Typ.)
6 GHz - 8 GHz	0 dBm (Typ.)
8 GHz - 14 GHz	2 dBm (Typ.)
14GHz - 20 GHz	0 dBm (Typ.)
20 GHz - 26.5 GHz	-6 dBm (Typ.)
Level resolution	0.05 dB

Test port output signal purity

Description	Specification
2nd or 3rd harmonics (0 dBm)	
100 kHz to 25 MHz	< -10 dBc (Typ.)
25 MHz to 8 GHz	< -10 dBc (Typ.)
9 GHz to 26.5 GHz	< -10 dBc (Typ.)
Non-harmonic spurious (0 dBm)	< -20 dBc (Typ.)

Test port input

Test port input levels

Description	Specification	Typical
Max input level		
30 kHz - 14 GHz	+10 dBm	
14 GHz - 26.5 GHz	+10 dBm	
Damage input level		
30 kHz - 26.5 GHz	+27 dBm (RF) or 35 V (DC)	
Precision		
30 kHz - 1 GHz	±2.0 dB@-10 dBm	±0.5 dB@-10 dBm
1 GHz - 20 GHz	±2.0 dB@-10 dBm	±0.2 dB@-10 dBm
20 GHz - 26.5 GHz	±2.5 dB@-10 dBm	±0.5 dB@-10 dBm
Crosstalk		
30 kHz - 100 kHz	-75 dB	-105 dB
100 kHz - 6 GHz	-75 dB	-120 dB
6 GHz - 9 GHz	-80 dB	-105 dB
9 GHz - 20 GHz	-95 dB	-105 dB
20 GHz - 26.5 GHz	-60 dB	-70 dB
Noise floor		
30 kHz - 50 kHz	-70 dBm/Hz	-80 dBm/Hz
50 kHz - 200 kHz	-90 dBm/Hz	-110 dBm/Hz
200 kHz - 6.2 GHz	-100 dBm/Hz	-120 dBm/Hz
6.2 GHz - 9 GHz ²	-100 dBm/Hz	-110 dBm/Hz
9 GHz - 20 GHz	-100 dBm/Hz	-115 dBm/Hz
20 GHz - 26.5 GHz	-80 dBm/Hz	-110 dBm/Hz
Compression level (+10 dBm)		
Magnitude		
30 kHz - 26.5 GHz		1 dB
Phase		
30 kHz - 26.5 GHz		5 deg

(2) Some special frequencies will degrade

Trace noise

Description	Specification	Typical
Note: Setting max output power		
Transmission trace noise magnitude		
30 kHz- 500 MHz (IFBW=10 kHz) ^[1]	0.009 dB rms	0.002 dB rms
500 MHz- 4.5 GHz (IFBW=10 kHz)	0.006 dB rms	0.0015 dB rms
4.5 GHz- 8 GHz (IFBW=10 kHz)	0.006 dB rms	0.0015 dB rms
8 GHz- 18 GHz (IFBW=10 kHz)	0.010 dB rms	0.003 dB rms
18 GHz- 26.5 GHz (IFBW=10 kHz)	0.020 dB rms	0.008 dB rms
Reflection trace noise magnitude		
30 kHz- 500 MHz (IFBW=10 kHz) ^[1]	0.009 dB rms	0.002 dB rms
500 MHz- 4.5 GHz (IFBW=10 kHz)	0.006 dB rms	0.0015 dB rms
4.5 GHz- 8 GHz (IFBW=10 kHz)	0.006 dB rms	0.0015 dB rms
8 GHz- 18 GHz (IFBW=10 kHz)	0.010 dB rms	0.003 dB rms
18 GHz- 26.5 GHz (IFBW=10 kHz)	0.020 dB rms	0.008 dB rms
Transmission trace noise phase		
30 kHz- 500 MHz (IFBW=10 kHz) ^[1]	0.09 deg rms	0.015 deg rms
500 MHz- 4.5 GHz (IFBW=10 kHz)	0.05 deg rms	0.01 deg rms
4.5 GHz- 8 GHz (IFBW=10 kHz)	0.05 deg rms	0.015 deg rms
8 GHz- 18 GHz (IFBW=10 kHz)	0.06 deg rms	0.025 deg rms
18 GHz- 26.5 GHz (IFBW=10 kHz)	0.12 deg rms	0.06 deg rms
Reflection trace noise phase		
30 kHz- 500 MHz (IFBW=10 kHz) ^[1]	0.09 deg rms	0.015 deg rms
500 MHz- 4.5 GHz (IFBW=10 kHz)	0.05 deg rms	0.01 deg rms
4.5 GHz- 8 GHz (IFBW=10 kHz)	0.05 deg rms	0.015 deg rms
8 GHz- 18 GHz (IFBW=10 kHz)	0.06 deg rms	0.025 deg rms
18 GHz- 26.5 GHz (IFBW=10 kHz)	0.12 deg rms	0.06 deg rms

[1] 21.25MHz frequency point does not meet the specification requirements

Stability

Description	Specification	Typical
Magnitude		
30 kHz- 1 MHz		± 0.02 dB/°C
1 MHz- 6 GHz		± 0.01 dB/°C
6 GHz- 14 GHz		± 0.025 dB/°C
14 GHz- 24 GHz		± 0.04 dB/°C
24 GHz- 26.5 GHz		± 0.1 dB/°C
Phase		
30 kHz- 1 MHz		± 0.4 deg/°C
1 MHz- 6 GHz		± 0.2 deg/°C
6 GHz- 14 GHz		± 0.5 deg/°C
14 GHz- 24 GHz		± 0.6 deg/°C
24 GHz- 26.5 GHz		± 1.0 deg/°C

Dynamic accuracy

Description	Specification
Relative to -10 dBm input power	
Magnitude	
10 dBm	± 2.29 dB
0 dBm	± 0.09 dB
-20 dBm	± 0.13 dB
-30 dBm	± 0.19 dB
-40 dBm	± 0.27 dB
-50 dBm	± 0.39 dB
-60 dBm	± 0.59 dB
-70 dBm	± 0.85 dB
-80 dBm	± 1.95 dB
-90 dBm	± 2.35 dB
-100 dBm	± 2.5 dB
Phase	
10 dBm	± 14.5 deg
0 dBm	± 1.45 deg
-20 dBm	± 1.85 deg
-30 dBm	± 3.99 deg
-40 dBm	± 5.27 deg
-50 dBm	± 6.39 deg
-60 dBm	± 8.59 deg
-70 dBm	± 10.85 deg
-80 dBm	± 11.95 deg
-90 dBm	± 12.35 deg
-100 dBm	± 16.5 deg

SA Mode

Description		Specification	Typical
Power range		-70 dBm - +10 dBm	
Noise floor	30 kHz - 1 MHz		-115 dBm/Hz
	1 MHz - 100 MHz		-110 dBm/Hz
	100 MHz - 5 GHz		-120 dBm/Hz
	5 GHz - 9 GHz ²		-105 dBm/Hz
	9 GHz - 22 GHz		-110 dBm/Hz
	22 GHz - 26.5 GHz		-100 dBm/Hz
Phase noise (Normal)			≤ -105 dBc/Hz (1 GHz@10 kHz) ≤ -110 dBc/Hz (1 GHz@100 kHz) ≤ -125 dBc/Hz (1 GHz@1 MHz)
Max input level without damaged		27 dBm	
Residual response			≤ -70 dBm

CAT Mode

Description	Specification
DTF	Range: Velocity Factor x Light Velocity x (Points Number- 1)/BW x 2 Resolution: Range/ (Points Number- 1)
Return loss range (dB)	-6k dB - +6k dB
VSWR resolution	1m dB - 1k dB
VSWR range	1.001 - 1G
VSWR resolution	0.001

Sweep time

Start frequency: 30 kHz, Stop frequency: 14 GHz; IFBW: 500 kHz.				
Points	201	401	1601	6401
2-port cal	28 ms	40 ms	160 ms	600 ms
Start frequency: 30 kHz, Stop frequency: 14 GHz; IFBW: 100 kHz.				
Points	201	401	1601	6401
2-port cal	30 ms	42 ms	180 ms	640 ms
Start frequency: 30 kHz, Stop frequency: 14 GHz; IFBW: 10 kHz.				
Points	201	401	1601	6401
2-port cal	60 ms	75 ms	350 ms	1400 ms
Start frequency: 30 kHz, Stop frequency: 14 GHz; IFBW: 1 kHz.				
Points	201	401	1601	6401
2-port cal	300 ms	500 ms	2500 ms	10000 ms
Start frequency: 30 kHz, Stop frequency: 26.5 GHz; IFBW: 500 kHz.				
Points	201	401	1601	6401
2-port cal	28 ms	40 ms	160 ms	600 ms
Start frequency: 30 kHz, Stop frequency: 26.5 GHz; IFBW: 100 kHz.				
Points	201	401	1601	6401
2-port cal	30 ms	42 ms	180 ms	640 ms
Start frequency: 30 kHz, Stop frequency: 26.5 GHz; IFBW: 10 kHz.				
Points	201	401	1601	6401
2-port cal	60 ms	75 ms	350 ms	1400 ms
Start frequency: 30 kHz, Stop frequency: 26.5 GHz; IFBW: 1 kHz.				
Points	201	401	1601	6401
2-port cal	300 ms	500 ms	2500 ms	10000 ms

General information

Description	Characteristics
Operating environment	
Temperature	0 to 50 °C
Humidity	20% to 80% at wet bulb temperature < +29 °C (non-condensation)
Altitude	0 to 3000 m
Non-operating storage environment	
Temperature	-20 °C to 70 °C
Humidity	20% to 90% at wet bulb temperature < +40 °C (non-condensation)
Altitude	0 to 15000 m
Size	W x H x D=310 mm x 215 mm x 78.5 mm
Weight	3.2 kg
EMC	
Conducted disturbance: CISPR 11/EN 55011	CLASS A group 1, 150 kHz - 30 MHz
Radiated disturbance: CISPR 11/EN 55011	CLASS A group 1, 30 MHz - 1 GHz
Electrostatic discharge (ESD): IEC61000-4-2/EN61000-4-2	4.0 kV (contact), 8.0 kV (air)
Radio-frequency electromagnetic field Immunity: IEC 61000-4-3/EN 61000-4-3	10 V/m (80 MHz to 1 GHz); 3 V/m (1.4 GHz to 2 GHz); 1 V/m (2.0 GHz to 2.7 GHz)
Electrical fast transients (EFT): IEC 61000-4-4/EN 61000-4-4	2 kV (AC power ports)
Surges: IEC 61000-4-5/EN 61000-4-5	1 kV (Line to line); 2 kV (Line to ground)
Radio-frequency continuous conducted Immunity: IEC 61000-4-6/EN 61000-4-6	3 V, 0.15-80 MHz
Voltage dips and interruptions: IEC 61000-4-11/EN 61000-4-11	Voltage dips: 0% UT during 1 cycle; 40% UT during 10/12 cycles; 70% UT during 25/30 cycles; Voltage interruptions: 0% UT during 250 cycles
Safety	
UL 61010-1:2012/R: 2018-11; CAN/CSA-C22.2 No. 61010-1:2012/A1:2018-11. UL 61010-2-030:2018; CAN/CSA-C22.2 No. 61010-2-030:2018.	

Panel information

Top Panel	
RF connectors	3.5 mm NMD (male), 50 Ω
USB Host	USB-A 2.0
USB Device	USB-C 2.0
LAN	LAN (VXI11), 10/100 Base, RJ-45
GPS Antenna	SMA Female, 3.3 V, 50 Ω
Bias Out	SMB Female, 12 V - 32 V, step 0.1 V
External Trigger Input	1 k Ω , 5 V TTL, BNC Female
10M Reference Input	10 MHz, -5 dBm ~ +10 dBm, BNC Female, 50 Ω
Remote control	
Hardware connectors	LAN, USB-TMC, GPIB (USB-GPIB adaptor)
Remote control interfaces	SCPI/ Labview/ IVI based on USB-TMC/ VXI-11/ GPIB/ Socket/Telnet NI-MAX Web Browser (HTML 5 Supported)

Physical Dimensions

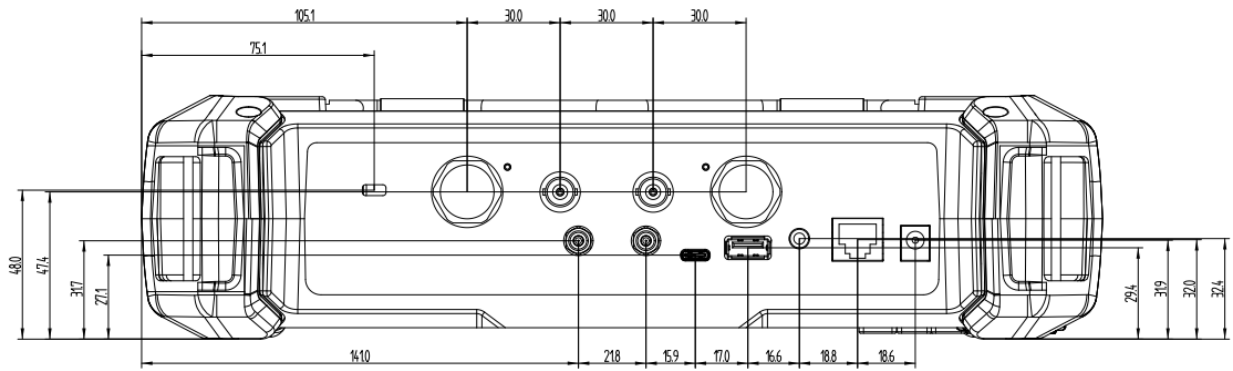

Top view (bottom near screen)

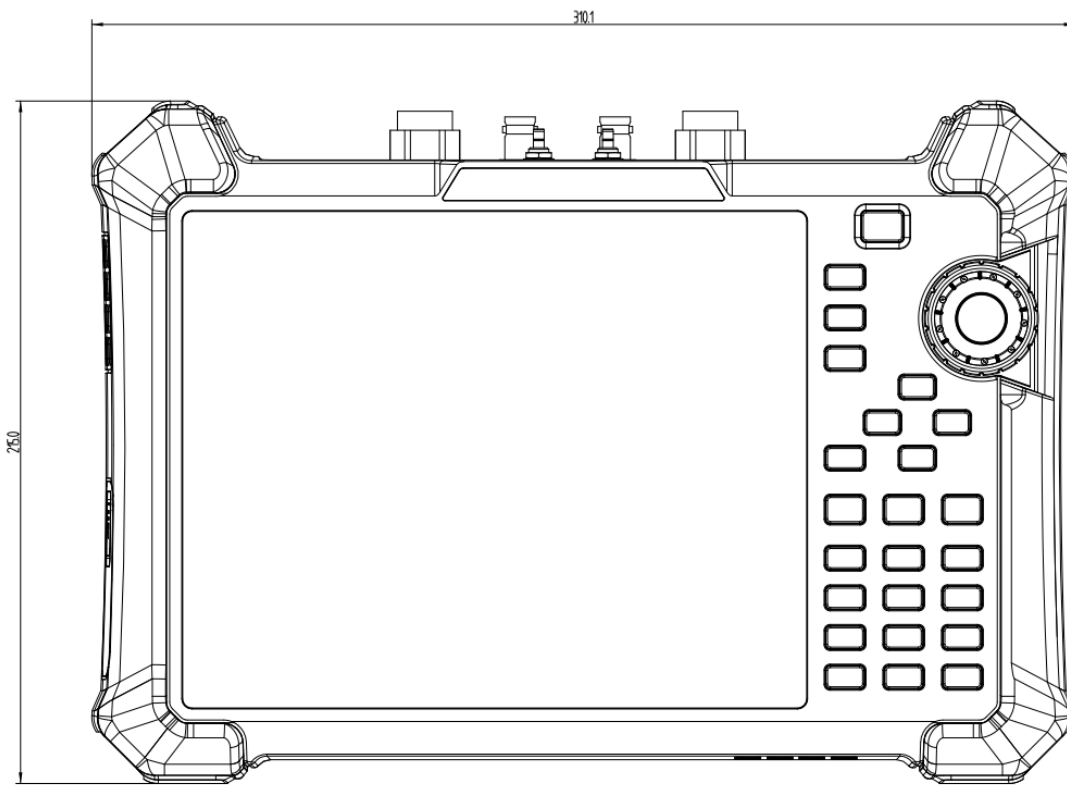

front view

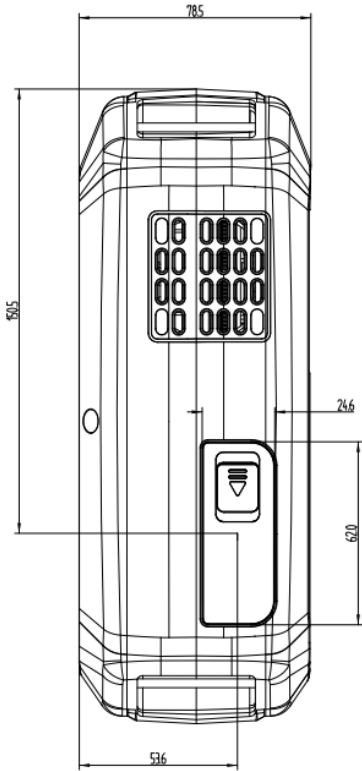

Side view Left (battery on the left side of the screen)

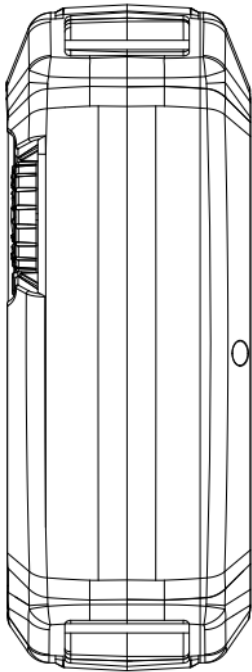

Side view Right

Ordering Information

Items	Description	Order number
Products	2 ports, 14 G Vector Network Analyzer	SHN914A
	2 ports, 20 G Vector Network Analyzer	SHN920A
	2 ports, 26.5 G Vector Network Analyzer	SHN926A
standard fittings	Quick Start, USB Type C Line, Rechargeable lithium battery, AC-DC adapter, Portable bag	
TDA Option	Time Domain Analysis	SHN900-TDA
TDR Option	Enhanced Time Domain Analysis	SHN900-TDR
SA Option	Spectrum analysis	SHN900-SA
AFR Option	Automatic Fixture Removal Software	SHN900-AFR
3.5 mm, Male, 50 Ω Calibration Kit, 0 - 4.5 GHz		F603ME
3.5 mm, Female, 50 Ω Calibration Kit, 0 - 4.5 GHz		F603FE
3.5 mm, Male, 50 Ω Calibration Kit, 0 – 9 GHz		F604MS
3.5 mm, Female, 50 Ω Calibration Kit, 0 – 9 GHz		F604FS
3.5 mm, Male and Female, 50 Ω Calibration Kit, 0 – 9 GHz		F604TS
3.5 mm, Male and Female, 50 Ω Calibration Kit, 0 - 26.5 GHz		F606TS
Electronic Calibration Kit		SEM5000A
RF Test Demo Board		SNA-TB01
Adjustable Differential TDR probe DC - 18 GHz		ADP-18
Adjustable Differential TDR probe DC - 26.5 GHz		ADP-26
Adjustable Differential TDR probe DC - 18 GHz		ASP-18
Adjustable Differential TDR probe DC - 26.5 GHz		ASP-26
SMA(M)-SMA(M) cable DC - 18 GHz, 1000 mm		SMA-SMA-18L
SMA(M)-SMA(M) cable DC - 26.5 GHz, 1000 mm		SMA-SMA-26L
SMA(F)-SMA(M) cable DC - 26.5 GHz, 1000 mm		SMAF-SMA-26L
NMD 3.5 female-NMD 3.5 Male DC - 26.5 GHz, 635 mm		V26-N35MN35F-25IN
NMD 3.5 female-APC 3.5 female DC - 26.5 GHz, 635 mm		V26-N35FA35F-25IN
USB-GPIB Adaptor		USB-GPIB
GPS antenna, SMA(M), 1000 mm		ANT-GPS1



About SIGLENT

SIGLENT is an international high-tech company, concentrating on R&D, sales, production and services of electronic test & measurement instruments.

SIGLENT first began developing digital oscilloscopes independently in 2002. After more than a decade of continuous development, SIGLENT has extended its product line to include digital oscilloscopes, isolated handheld oscilloscopes, function/arbitrary waveform generators, RF/MW signal generators, spectrum analyzers, vector network analyzers, digital multimeters, DC power supplies, electronic loads and other general purpose test instrumentation. Since its first oscilloscope was launched in 2005, SIGLENT has become the fastest growing manufacturer of digital oscilloscopes. We firmly believe that today SIGLENT is the best value in electronic test & measurement.

Headquarters:

SIGLENT Technologies Co., Ltd
Add: Bldg No.4 & No.5, Antongda Industrial Zone,
3rd Liuxian Road, Bao' an District,
Shenzhen, 518101, China
Tel: + 86 755 3688 7876
Fax: + 86 755 3359 1582
Email: sales@siglent.com
Website: int.siglent.com

North America:

SIGLENT Technologies NA, Inc
Add: 6557 Cochran Rd Solon, Ohio 44139
Tel: 440-398-5800
Toll Free:877-515-5551
Fax: 440-399-1211
Email: support@siglentna.com
Website: www.siglentna.com

Europe:

SIGLENT Technologies Germany GmbH
Add: Staetzlinger Str. 70
86165 Augsburg, Germany
Tel: +49(0)-821-666 0 111 0
Fax: +49(0)-821-666 0 111 22
Email: info-eu@siglent.com
Website: www.siglenteu.com

Malaysia:

SIGLENT Technologies (M) Sdn.Bhd
Add: NO.6 Lorong Jelawat 4
Kawasan Perusahaan Seberang Jaya
13700, Perai Pulau Pinang

Follow us on
Facebook: SiglentTech

