

# SDL1000X

## Series

Programmable DC  
Electronic Load

 SIGLENT®



INSTRUMENTS  
**TECHNO  
TEST**



DataSheet-2019.10

# SDL1020X SDL1020X-E SDL1030X SDL1030X-E

## Product Overview

SDL1000X/SDL1000X-E series Programmable DC Electronic Load has a 3.5 inch TFT-LCD display, a user-friendly interface and superb performance specifications. The SDL1020X/SDL1020X-E models feature an input range of 150 V/30 A 200 W while the SDL1030X/SDL1030X-E have an input range of 150 V/30 A 300 W. The SDL1000X series leads with measurement resolution of 0.1 mV/0.1 mA and the base SDL1000X-E series resolution is 1 mV/1 mA and adjustable current rise times from 0.001 A/ $\mu$ s~2.5 A/ $\mu$ s. For remote communication and control, the SDL series includes RS232/USB/LAN interface types. The SDL1000X series delivers stability over a wide range of applications and can meet all kinds of testing requirements. including: Power, battery/handheld device design, industry, LED lighting, automotive electronics, and aerospace.

## Main Feature

- 🔌 SDL1020X (Single channel ): DC 150 V/30 A, total power up to 200 W
- 🔌 SDL1030X (Single channel ): DC 150 V/30 A, total power up to 300 W
- 🔌 4 static modes / Dynamic mode: CC/CV/CR/CP
- 🔌 CC Dynamic mode: Continuous, pulsed, toggled
- 🔌 CC Dynamic mode: 25 kHz, CP Dynamic mode: 12.5 kHz, CV Dynamic mode: 0.5 Hz
- 🔌 Measuring speed of voltage and current: up to 500 kHz
- 🔌 Adjustable current rise time range: 0.001 A/ $\mu$ s~2.5 A/ $\mu$ s
- 🔌 Min. readback resolution: 0.1 mV, 0.1 mA
- 🔌 Short-circuit, Battery test, CR-LED mode, and factory test functions
- 🔌 4-wire SENSE compensation mode function
- 🔌 List function supports editing as many as 100 steps
- 🔌 Program function supports 50 groups of steps
- 🔌 OCP, OVP, OPP, OTP and LRV protection
- 🔌 External analog control
- 🔌 Voltage, Current monitoring via 0-10 V
- 🔌 3.5 inch TFT-LCD display, capable of displaying multiple parameters and states simultaneously
- 🔌 Built-in RS232/USB/LAN communication interface, USB-GPIB module (optional)
- 🔌 Waveform trend chart and ease-to-use file storage and call functions
- 🔌 Includes PC software: Supports SCPI, LabView driver

## Design Features

### Steady state operating mode

The SDL features four operating modes to provide flexible test capabilities. In CC mode, the electronic load will sink a constant current, regardless of the voltage at its terminals. In CV mode, the electronic load will cause a constant voltage to appear at its terminals. In CR mode, the electronic load will behave as a fixed resistance value. As shown in the figure, the electronic load will linearly change the current according to the input voltage. In CP mode, the electronic load will cause a constant power to be dissipated in the load.

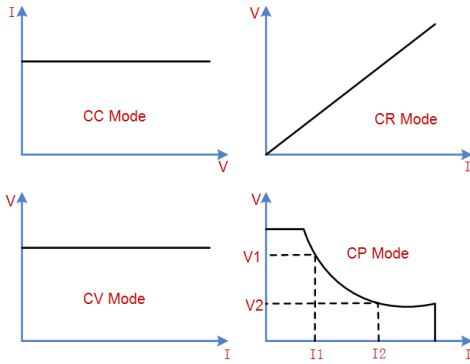

### Dynamic test mode up to 25 kHz (CC)

The transient test allows switching between two different load values. A common application is to test the dynamic characteristics of a DC source or DUT (Device Under Test). The transient test function enables the load to periodically switch between two set levels (Level A and Level B). The highest frequency can be set to 25 kHz in CC mode. The highest frequency can be set to 12.5 kHz in CP modes.

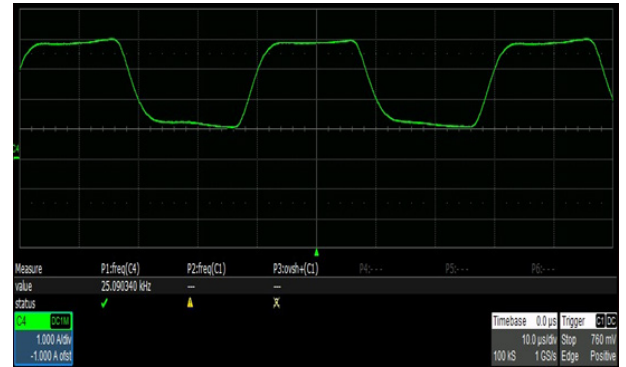

### Simplify complex sequencing using the list operation function

You can generate complex load sequences quickly using the list operation function. Here, you can edit the setpoints, dwell time, and slew rate for each step in the test. \*Slew rate can only be edited in CC mode.

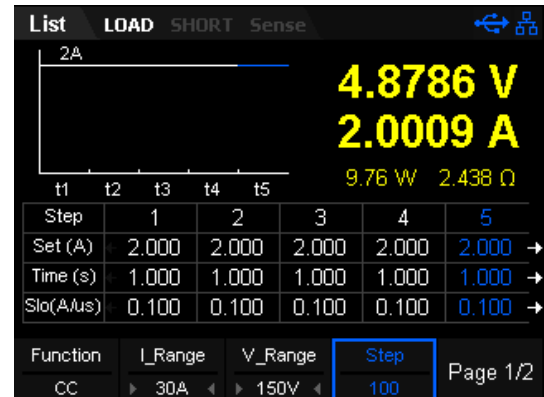
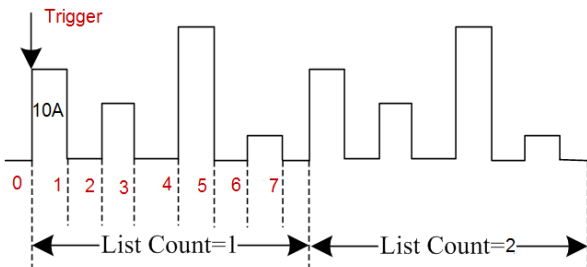

### 4-wire SENSE compensation mode function

In CC/CV/CR/CW mode, when a load is connected to a power supply, it will cause a large voltage-drop on the connection lines between tested instrument and terminals of load. Using remote sense, you can measure the voltage at the DUTs input terminals, effectively removing the additional error due to the voltage drop in the connection wires.

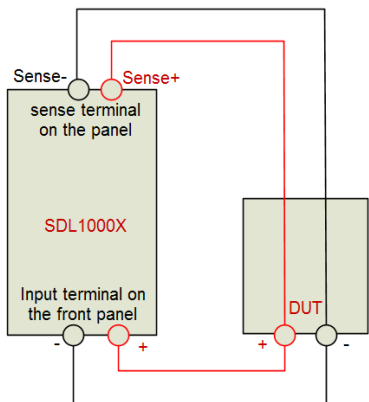

## Program function

In program (auto-test) mode, you can generate a sequence of tests using different modes, mode parameters and durations. This function is useful for automatically executing a set of tests on a device then display whether the tests passed or failed. Test results are easily viewed by pressing the up and down buttons. The load provides 8 nonvolatile registers to save auto-test file for recall later. Each file contains 1-50 steps to set up. Auto-test function is especially useful in the designing battery charging circuitry.

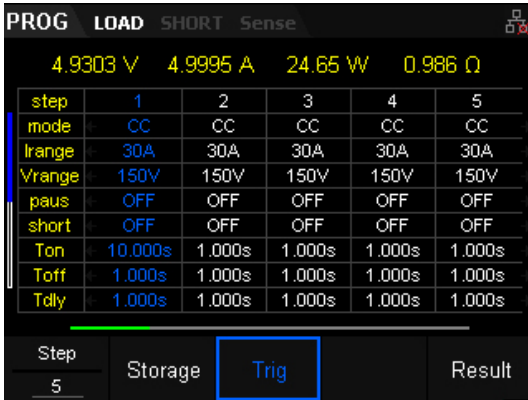

## Battery discharge function

The SDL1000X can also provide insight into battery performance by analyzing the discharge characteristics of the DUT. The SDL features three stop conditions for the discharge test: Voltage, capacity or time. The discharge process is immediately terminated if the stop conditions are met. This provides more control over the test termination and an extra layer of safety during critical tests. Throughout the test process the battery voltage, discharge current, discharge time and discharged capability is displayed clearly on the LCD panel.

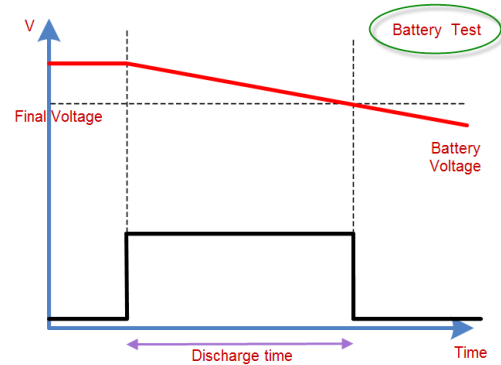

## OCPT/OPPT Mode

Over-current protection (OCPT) mode prevents drawing too much current from the DUT. After the input voltage reaches the Von point, the DC load will start to draw a current from the source after a delay time. The current value will increase by a certain step size at regular intervals. Simultaneously, the DC load will compare the input voltage to the OCP voltage: If it is lower, then the present current value will be compared to see if it is in the current range you have set. Within the range, the OCP test will evaluate Pass or Fail. If it is outside of the set range, the DC load will increase drawing current and compare the voltage again.

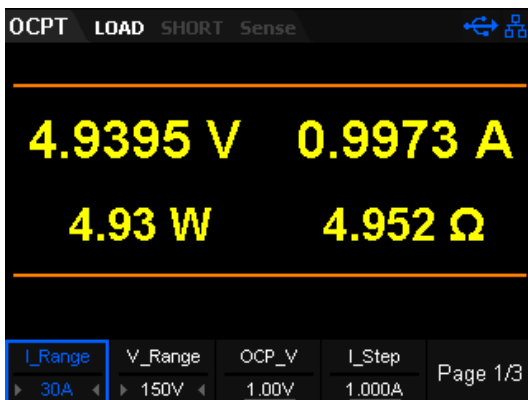

Overpower-protection (OPPT) mode: When the input voltage has reached the Von point, the load will draw power after a delay time. The power value will increase by a step size at regular intervals. Simultaneously, the DC load will judge whether the input voltage is lower than OPP voltage you have set, if it is, then the present current value will be compared to see if it is in the current range you have set. Within the range, the OPP test will Pass or Fail. If it is outside of the set power, the load will continue to increase the power draw within the cut-off current range and compare OPP voltage with the input.

## CR-LED Mode

The SDL1000X includes a CR-LED mode specifically for LED driver testing. Basing on the traditional CR mode, CR-LED mode adds a diode break-over voltage setting. When the input voltage is above this set value, the DC load start to work. Thus, it can emulate the actual characteristics of an LED.



### Voltage Rise/Fall speed test

The electronic load is also equipped to directly measure voltage rise and fall times. It can calculate the time from one voltage to another without the need for additional measurement instrumentation. With an SDL1000X, you can save money and improve efficiency.

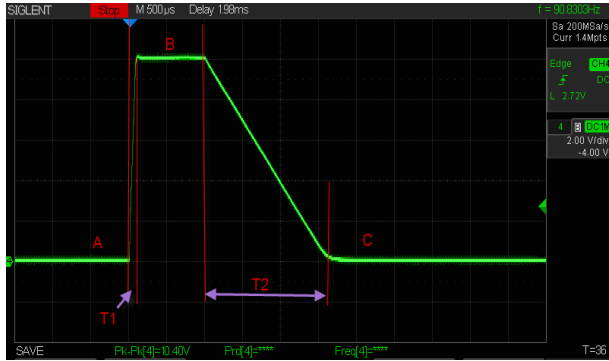

### Waveform trend chart function

The electronic load includes a waveform display function and supports the following operations for the waveform: Pause, recording, and capturing the waveform. You can quickly observe the trends of parameter changes as they occur throughout the test.

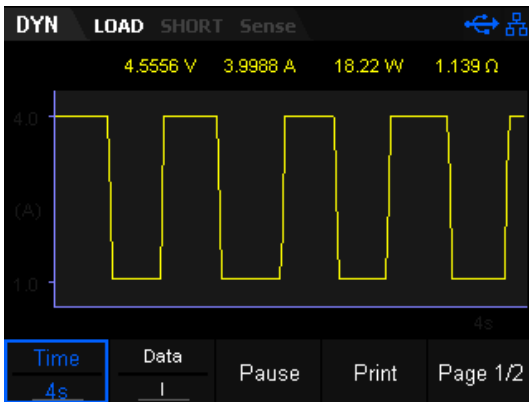

### External analog control

The load allows the user to control current or voltage through external analog terminals (EXT PRG). Input a 0-10 V analog to adjust 0-100% rated voltage and current. It is very useful for those applications that need to change the input value with external signals.

### Voltage threshold function

The SDL1000X can be set to turn on or off if the input voltage is at, above, or below a set value. By defining these thresholds, you control when the load is active. Which minimizes test time and increases safety.

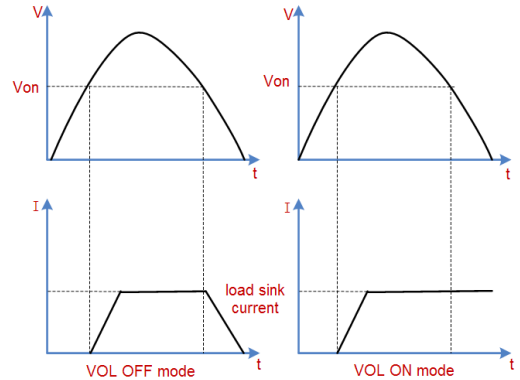

### Save/Recall setting parameters

The load allows you to save different types of files to the internal and external memories. You can recall and read them when necessary.

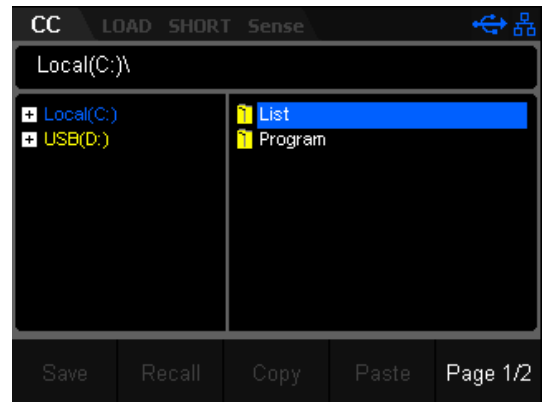

### Multiple protection modes

The SDL1000X series Programmable DC Electronic Load provides five protection types: OVP, OCP, OPP, OTP and LRV. When OVP/OCP/OPP/OTP/reverse voltage protection (LRV) occurs, the load will immediately turn off the input and stop sinking. Then, a prompt message is displayed.

## Specifications

Unless otherwise noted, all specifications are guaranteed within the temperature range of  $25^{\circ}\text{C} \pm 5^{\circ}\text{C}$  with warm-up time of 30 minutes.

Model		SDL1020X		SDL1020X-E	
Input Rating (0~40 °C)	Input voltage	0~150 V			
	Input current	0~5 A	0~30 A	0~5 A	0~30 A
	Input power	200 W			
	Minimum Operating Voltage (DC)	0.15 V at 5 A	0.9 V at 30 A	0.15 V at 5 A	0.9 V at 30 A
CV Mode	Range	0~36 V	0~150 V	0~36 V	0~150 V
	Resolution	1 mV		1 mV	
	Accuracy	$\pm (0.05\%+0.025\%\text{FS}) 50 \text{ ppm}/^{\circ}\text{C}$		$\pm (0.05\%+0.025\%\text{FS}) 50 \text{ ppm}/^{\circ}\text{C}$	
CC Mode	Range	0~5 A	0~30 A	0~5 A	0~30 A
	Resolution	1 mA		1 mA	
	Accuracy *2	$\pm (0.05\%+0.05\%\text{FS}) 100 \text{ ppm}/^{\circ}\text{C}$		$\pm (0.1\%+0.1\%\text{FS}) 100 \text{ ppm}/^{\circ}\text{C}$	
CR Mode *1	Range	0.03 $\Omega$ ~10 k $\Omega$			
	Resolution	1mA/Vsense			
	Accuracy	0.01%+0.0008 s [1]			
CP Mode *3	Range	200 W			
	Resolution	10 mW			
	Accuracy	0.1%+0.1% FS			
<b>Dynamic Model</b>					
<b>CC Mode</b>					
T1&T2		20 $\mu\text{s}$ ~999 S/Res: 1 $\mu\text{s}$		20 $\mu\text{s}$ ~999 S/Res: 1 $\mu\text{s}$	
Accuracy		20 $\mu\text{s}$ ~200 ms/Acc: 5 $\mu\text{s}$ , 200 ms ~999 s/Acc: 5 ms		20 $\mu\text{s}$ ~200 ms/Acc: 5 $\mu\text{s}$ , 200 ms ~999 s/Acc: 5 ms	
Current Slew Rate *4		0.001~0.5 A/ $\mu\text{s}$	0.001~2.5 A/ $\mu\text{s}$	0.001~0.5 A/ $\mu\text{s}$	0.001~2.5 A/ $\mu\text{s}$
Minimum Rise Time		$\approx 10 \mu\text{s}$	$\approx 12 \mu\text{s}$	$\approx 10 \mu\text{s}$	$\approx 12 \mu\text{s}$
<b>Measuring Range</b>					
Readback Voltage	Range	0~36 V	0~150 V	0~36 V	0~150 V
	Resolution	0.1 mV	1 mV	1 mV	
	Accuracy	$\pm (0.025\%+0.025\%\text{FS}) 20 \text{ ppm}/^{\circ}\text{C}$		$\pm (0.05\%+0.02\%\text{FS}) 20 \text{ ppm}/^{\circ}\text{C}$	
Readback Current	Range	0~5 A	0~30 A	0~5 A	0~30 A
	Resolution	0.1 mA		1 mA	
	Accuracy	$\pm (0.05\%+0.05\%\text{FS}) 50 \text{ ppm}/^{\circ}\text{C}$		$\pm (0.05\%+0.05\%\text{FS}) 50 \text{ ppm}/^{\circ}\text{C}$	
Readback Power	Range	200 W			
	Resolution	10 mW			
	Accuracy	$\pm (0.1\%+0.1\%\text{FS})$			
Readback Resistance	Range	0.03 $\Omega$ ~10 k $\Omega$			
	Resolution	0.001 $\Omega$			

Protection Range					
<b>OPP</b>	210 W				
<b>OCP</b>		5.1 A	31 A	5.1 A	31 A
<b>OVP</b>		41 V	155 V	41 V	155 V
<b>OTP</b>	85 °C				
<b>Battery Measurement</b>	Battery Input: 0.5~150 V; Max Measurement: Capacity=999 AH Resolution=0.1 mA;Time Range=1 s~24 H				
<b>Input Resistance</b>	>200 kΩ				
<b>Dimension</b>	256 * 115 * 410 (WxHxD mm)				
<b>Weight</b>	5.8 kg				

Model	SDL1030X			SDL1030X-E	
<b>Input Rating</b> (0~40 °C )	<b>Input Voltage</b>	0~150 V			
	<b>Input Current</b>	0~5 A	0~30 A	0~5 A	0~30 A
	<b>Input Power</b>	300 W			
	<b>Minimum Operating Voltage (DC)</b>	0.15 V at 5 A	0.9 V at 30 A	0.15 V at 5 A	0.9 V at 30 A
<b>CV Mode</b>	<b>Range</b>	0~36 V	0~150 V	0~36 V	0~150 V
	<b>Resolution</b>	1 mV			1 mV
	<b>Accuracy</b>	± (0.05%+0.025%FS) 50 ppm/°C			± (0.05%+0.025%FS) 50 ppm/°C
<b>CC Mode</b>	<b>Range</b>	0~5 A	0~30 A	0~5 A	0~30 A
	<b>Resolution</b>	1 mA			1 mA
	<b>Accuracy *2</b>	± (0.05%+0.05%FS) 100 ppm/°C			± (0.1%+0.1%FS) 100 ppm/°C
<b>CR Mode *1</b>	<b>Range</b>	0.03 Ω~10 kΩ			
	<b>Resolution</b>	1mA/Vsense			
	<b>Accuracy</b>	0.01%+0.0008 s [1]			
<b>CP Mode *3</b>	<b>Range</b>	300 W			
	<b>Resolution</b>	10 mW			
	<b>Accuracy</b>	0.1%+0.1% FS			
Dynamic Model					
CC Mode					
<b>T1&amp;T2</b>	20 us~999 S/Res: 1 uS			20 us~999 S/Res: 1 uS	
<b>Accuracy</b>	20 us~200 ms/Acc: 5 us, 200 ms ~999 s/Acc: 5 ms			20 us~200 ms/Acc: 5 us, 200 ms ~999 s/Acc: 5 ms	
<b>Current Slew Rate *4</b>	0.001~0.5 A/us	0.001~2.5 A/us		0.001~0.5 A/us	0.001~2.5 A/us
<b>Minimum Rise Time</b>	≈10 uS	≈12 uS		≈10 uS	≈12 uS
Measuring Range					
<b>Readback Voltage</b>	<b>Range</b>	0~36 V	0~150 V	0~36 V	0~150 V
	<b>Resolution</b>	0.1 mV	1 mV	1 mV	
	<b>Accuracy</b>	± (0.025%+0.025% FS) 20 ppm/°C			± (0.05%+0.02% FS) 20 ppm/°C

<b>Readback Current</b>	<b>Range</b>	0~5 A	0~30 A	0~5 A	0~30 A
	<b>Resolution</b>	0.1 mA			1 mA
	<b>Accuracy</b>	± (0.05%+0.05% FS) 50 ppm/°C			± (0.05%+0.05% FS) 50 ppm/°C
<b>Readback Power</b>	<b>Range</b>	300 W			
	<b>Resolution</b>	10 mW			
	<b>Accuracy</b>	± (0.1%+0.1% FS)			
<b>Readback Resistance</b>	<b>Range</b>	0.03 Ω~10 KΩ			
	<b>Resolution</b>	0.001Ω			
<b>Protection Range</b>					
<b>OPP</b>	310 W				
<b>OCP</b>		5.1 A	31 A	5.1 A	31 A
<b>OVP</b>		41 V	155 V	41 V	155 V
<b>OTP</b>	95 °C				
<b>Battery Measurement</b>	Battery Input: 0.5~150 V; Max Measurement: Capacity=999 AH Resolution=0.1 mA;Time Range=1 s~24 H				
<b>Input Resistance</b>	>200 kΩ				
<b>Dimension</b>	256 * 115 * 410 (WxHxD mm)				
<b>Weight</b>	5.8 kg				

<b>CR Mode *1</b>					
<b>I Range</b>	<b>V Range</b>	<b>R Range</b>	<b>Accuracy</b>	<b>Test Condition</b>	
<b>5 A</b>	<b>36 V</b>	0.03 Ω~10 kΩ	0.01%+0.08 s (0.05~10 Ω) 0.01%+0.0008 s (10~10000 Ω) [1]	The input voltage/current value should not be smaller than 10% of the full scale	
	<b>150 V</b>				
<b>30 A</b>	<b>36 V</b>				
	<b>150 V</b>				
[1] Resistance Range: $(1/(1/R+(1/R)*0.01\%+0.0008),1/(1/R-(1/R)*0.01\%-0.0008))$					

\*2 Current Slew rate>0.2 A/us

\*3 The input voltage/current value should not be smaller than 10% of the full scale.

\*4 Current slew rate: rising slew rate for 10%~90% of the current (0-maximum current).

Product information	Product No
150 V/30 A 200 W Programmable DC Electronic Load	SDL1020X/SDL1020X-E
150 V/30 A 300 W Programmable DC Electronic Load	SDL1030X/SDL1030X-E
<b>Standard Accessories</b>	
USB Cable -1	
Quick Start -1	
Calibration Certificate -1	
Power cord -1	
<b>Optional accessories</b>	
30 A Test Lead	

## Accessories Description

Model	30 A Test Lead
Maximum Current	30A
Maximum Voltage	150V
Terminal	M6/M6
Wire Gauge	AWG 10
Length	1010±10mm
Exterior Design	

## Warranty

Three-year warranty, excluding accessories.

# SDL1000X Series Programmable DC Electronic Load



## About SIGLENT

SIGLENT is an international high-tech company, concentrating on R&D, sales, production and services of electronic test & measurement instruments.

SIGLENT first began developing digital oscilloscopes independently in 2002. After more than a decade of continuous development, SIGLENT has extended its product line to include digital oscilloscopes, function/arbitrary waveform generators, RF generators, digital multimeters, DC power supplies, spectrum analyzers, vector network analyzers, isolated handheld oscilloscopes, electronic load and other general purpose test instrumentation. Since its first oscilloscope, the ADS7000 series, was launched in 2005, SIGLENT has become the fastest growing manufacturer of digital oscilloscopes. We firmly believe that today SIGLENT is the best value in electronic test & measurement.

### Headquarters:

SIGLENT Technologies Co., Ltd  
Add: Bldg No.4 & No.5, Antongda Industrial  
Zone, 3rd Liuxian Road, Bao'an District,  
Shenzhen, 518101, China  
Tel: + 86 755 3688 7876  
Fax: + 86 755 3359 1582  
Email: sales@siglent.com  
Website: int.siglent.com

### USA:

SIGLENT Technologies America, Inc  
6557 Cochran Rd Solon, Ohio 44139  
Tel: 440-398-5800  
Toll Free: 877-515-5551  
Fax: 440-399-1211  
Email: info@siglent.com  
Website: www.siglentna.com

### Europe:

SIGLENT Technologies Germany GmbH  
Add: Liebigstrasse 2-20, Gebaeude 14,  
22113 Hamburg Germany  
Tel: +49(0)-819-95946  
Fax: +49(0)-819-95947  
Email: info-eu@siglent.com  
Website: www.siglenteu.com

Follow us on  
Facebook: SiglentTech

